

Hold	Skive	Josefine Laursen	
117	1		
50m		Viborg Skytteforening	
01.08.2015		DSU stævne 2015	Aalborg Skyttekreds
Prøve Knæ		1: 9.3 → 2: 7.3 → 3: 7.4 → 4: 10.4x → 5: 8.6 → 6: 9.5 → 7: 10.0 ↓ 8: 9.6 ← 9: 8.6 ↓ 10: 8.7 ↓	Prøve Knæ 11: 10.3x ↗
		Serie 85.0 Total 0.0	Serie 10.0 Total 0.0
Knæ		1: 9.5 ← 2: 10.4x ↗ 3: 9.4 ↗ 4: 9.0 ↗ 5: 10.1 → 6: 9.9 ↓ 7: 9.9 ← 8: 9.8 ← 9: 10.3x ↓ 10: 9.9 ↓	Prøve Ligg 1: 8.6 ↓ 2: 9.8 ← 3: 8.4 ↙ 4: 9.1 ← 5: 10.4x ↗ 6: 10.0 ↓ 7: 10.2 ↓ 8: 10.6x ↑ 9: 10.4x ↗ 10: 10.8x ←
		Serie 93.0 Total 93.0	Serie 94.0 Total 93.0
2. Serie 40 Ligg		1: 9.9 ↗ 2: 9.4 ↘ 3: 9.7 ↘ 4: 9.7 → 5: 10.7x ← 6: 10.5x ↗ 7: 10.4x ↙ 8: 10.3 ↗ 9: 10.5x ← 10: 8.5 ↗	2. Serie 40 Ligg 11: 10.4x → 12: 10.8x ↗ 13: 9.6 ← 14: 9.2 ↓ 15: 9.6 ↙ 16: 10.4x ↗ 17: 9.6 ↗ 18: 10.2 ↑ 19: 10.6x ↗ 20: 10.5x ↙
		Serie 94.0 Total 187.0	Serie 96.0 Total 283.0
2. Serie 40 Ligg		21: 9.4 ↗ 22: 9.7 ↗ 23: 10.1 ↙ 24: 9.6 ↘ 25: 9.5 ↘ 26: 10.1 ↗ 27: 10.1 → 28: 10.3 ↘ 29: 10.5x → 30: 9.7 ↘	2. Serie 40 Ligg 31: 10.1 ↗ 32: 10.4x → 33: 10.5x ↙ 34: 10.2 ↗ 35: 10.1 ← 36: 10.2 ↓ 37: 10.0 → 38: 10.1 ↗ 39: 10.5x → 40: 10.6x →
		Serie 95.0 Total 378.0	Serie 100.0 Total 478.0
Prøve Stå		1: 8.3 → 2: 5.7 ↘ 3: 10.3 ↙ 4: 8.9 → 5: 10.2 → 6: 9.0 → 7: 9.2 ↑ 8: 10.2 → 9: 8.9 ↘	3. Serie Stå 1: 9.2 ↓ 2: 8.4 ← 3: 9.3 ↗ 4: 9.7 ↘ 5: 8.7 → 6: 10.4x ↓ 7: 8.4 → 8: 10.2 ↓ 9: 10.3x ↓ 10: 9.8 ↘
		Serie 77.0 Total 478.0	Serie 90.0 Total 568.0

Hold	Skive	Nanna Bissø			
117	2				
50m	ÅRK				
01.08.2015	DSU stævne 2015	Aalborg Skyttekreds			
Prøve Knæ	1: 8.5 ↗ 2: 10.7x → 3: 9.2 ↘ 4: 9.4 ↗ 5: 9.7 ↖ 6: 7.8 ↗ 7: 9.4 ↗ 8: 9.3 ↘ 9: 9.8 ↓ 10: 10.3x ↗	Prøve Knæ	11: 9.3 ↖ 12: 10.1 ↖ 13: 9.8 ↗ 14: 10.7x ↖ 15: 9.9 ↘ 16: 10.1 ↖	20 Knæ	1: 9.9 ↘ 2: 9.5 ↖ 3: 10.6x ↘ 4: 10.9x ↘ 5: 9.7 ↘ 6: 10.5x ↖ 7: 10.5x ↘ 8: 9.9 ↘ 9: 10.8x ↗ 10: 9.9 ↗
	Serie 89.0 Total 0.0		Serie 57.0 Total 0.0		Serie 95.0 Total 95.0
20 Knæ	11: 9.4 ↘ 12: 9.5 ↘ 13: 8.3 ↘ 14: 9.2 ↘ 15: 9.7 ↘ 16: 9.2 ↗ 17: 10.6x ↘ 18: 10.4x ↘ 19: 9.1 ↗ 20: 10.2 ↗	Prøve Ligg	1: 9.1 ↗ 2: 8.5 ↗ 3: 10.1 ↗ 4: 10.2 ↗ 5: 9.5 ↗ 6: 10.1 ↖ 7: 10.3x ↗ 8: 10.3x ↖ 9: 10.1 ↘ 10: 9.7 ↘	Prøve Ligg	11: 9.9 ↖ 12: 10.0 ↖ 13: 10.1 ↘ 14: 10.4x ↘ 15: 10.0 ↘ 16: 8.9 ↘ 17: 9.1 →
	Serie 92.0 Total 187.0		Serie 95.0 Total 187.0		Serie 66.0 Total 187.0
2. Serie 60 Ligg	1: 9.8 ↘ 2: 10.3 ↖ 3: 10.4x ↘ 4: 9.9 ↗ 5: 10.8x ↗ 6: 10.5x ↘ 7: 10.7x ↗ 8: 10.0 ↘ 9: 9.9 ↗ 10: 9.6 ↖	2. Serie 60 Ligg	11: 10.7x ↗ 12: 9.5 ↘ 13: 10.5x → 14: 9.7 ↖ 15: 10.3x ↗ 16: 10.2 ↘ 17: 10.6x ↗ 18: 8.9 ↖ 19: 10.2 ↗ 20: 10.2 ↖	2. Serie 60 Ligg	21: 10.1 ↗ 22: 9.6 ↘ 23: 10.1 ↗ 24: 10.0 ↖ 25: 10.6x ↗ 26: 10.5x ↘ 27: 10.3x ↘ 28: 10.1 ↗ 29: 9.5 → 30: 10.6x ↖
	Serie 96.0 Total 283.0		Serie 96.0 Total 379.0		Serie 98.0 Total 477.0
2. Serie 60 Ligg	31: 9.9 ↖ 32: 9.0 → 33: 9.9 ↖ 34: 10.8x ↘ 35: 10.8x ↘ 36: 9.9 ↗ 37: 10.3x ↘ 38: 9.5 ↗ 39: 10.6x ↘ 40: 9.6 →	2. Serie 60 Ligg	41: 10.3 ↘ 42: 10.7x ↘ 43: 10.6x → 44: 10.8x ↖ 45: 10.3 ↘ 46: 10.0 → 47: 9.8 ↖ 48: 10.6x → 49: 10.0 ↗ 50: 10.4x ↘	2. Serie 60 Ligg	51: 10.6x ↗ 52: 10.7x ↘ 53: 10.3x ↘ 54: 10.2 ↗ 55: 9.6 ↖ 56: 10.0 ↖ 57: 10.6x ↗ 58: 10.4x → 59: 9.5 → 60: 10.2 ↘
	Serie 94.0 Total 571.0		Serie 99.0 Total 670.0		Serie 98.0 Total 768.0
Prøve Stå	1: 7.2 ↘ 2: 8.1 ↘ 3: 10.2 ↖ 4: 9.4 ↖ 5: 10.0 ↗ 6: 10.1 ↖ 7: 9.6 → 8: 10.7x ↖ 9: 9.9 ↗ 10: 9.4 →	Prøve Stå	11: 10.2 → 12: 9.4 ↗	3. Serie 20 Stå	1: 10.4x ↘ 2: 9.3 ↗ 3: 10.2 ↗ 4: 10.0 ↖ 5: 9.3 ↖ 6: 8.4 → 7: 9.1 → 8: 10.6x ↗ 9: 8.1 ↗ 10: 10.0 →
	Serie 91.0 Total 768.0		Serie 19.0 Total 768.0		Serie 93.0 Total 861.0

3. Serie 20 Stå

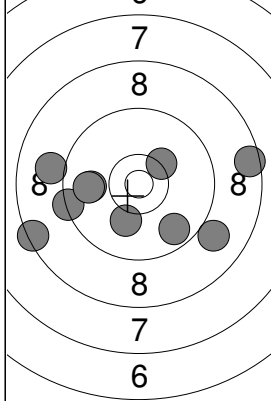

11:	9.9	←
12:	8.4	←
13:	10.1	↓
14:	9.4	←
15:	10.3x	↗
16:	9.0	↘
17:	9.7	↘
18:	9.0	←
19:	8.5	→
20:	9.9	←
Serie	90.0	
Total	951.0	

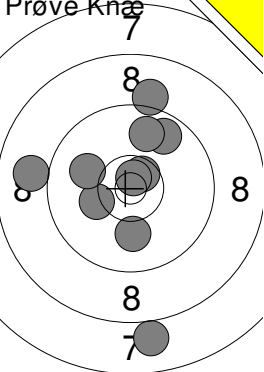
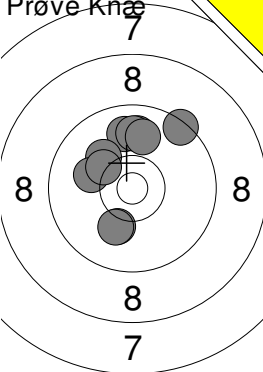
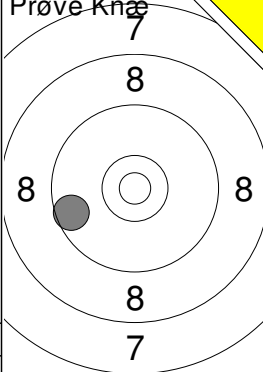
Prøve Knæ 	1: 8.0 ↓ 2: 10.2 ← 3: 10.0 ← 4: 10.6x ↗ 5: 9.7 ↗ 6: 10.1 ↓ 7: 9.8 ↗ 8: 9.1 ↗ 9: 10.7x ↗ 10: 9.0 ← Serie 94.0 Total 0.0	Prøve Knæ 	11: 9.9 ↑ 12: 9.9 ↑ 13: 10.1 ↗ 14: 10.2 ↓ 15: 10.1 ↓ 16: 9.4 ↗ 17: 10.1 ← 18: 9.9 ↑ 19: 10.2 ↗ 20: 9.9 ↑ Serie 95.0 Total 0.0	Prøve Knæ 	21: 9.6 ← Serie 9.0 Total 0.0
---	---	--	--	--	-------------------------------------

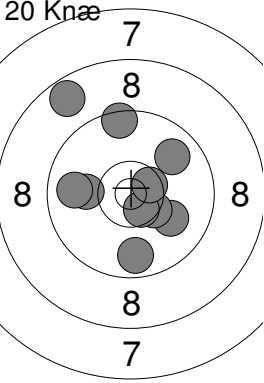
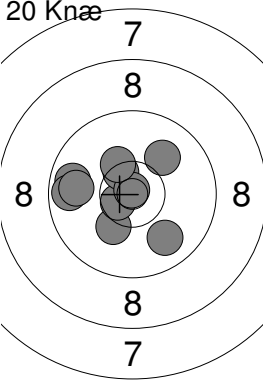
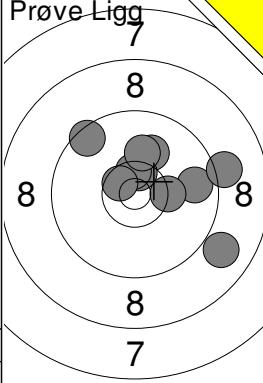
20 Knæ 	1: 10.0 → 2: 9.7 ↓ 3: 10.4x → 4: 8.7 ↗ 5: 10.1 ← 6: 9.9 ↗ 7: 9.5 ↗ 8: 10.6x ↓ 9: 10.5x → 10: 9.8 ← Serie 94.0 Total 94.0	20 Knæ 	11: 10.2 ↓ 12: 10.6x ← 13: 10.0 ↗ 14: 9.9 ↓ 15: 9.7 ← 16: 10.5x ↗ 17: 9.7 ← 18: 9.8 ← 19: 10.9x ↑ 20: 10.3x ↗ Serie 96.0 Total 190.0	Prøve Ligg 	1: 10.1 ↗ 2: 9.8 → 3: 10.5x ↑ 4: 9.5 ↗ 5: 8.9 ↓ 6: 10.3x → 7: 10.5x ↑ 8: 10.6x ↗ 9: 9.1 → 10: 10.1 ↑ Serie 95.0 Total 190.0
--	---	---	---	---	--

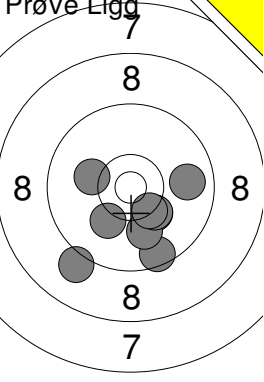
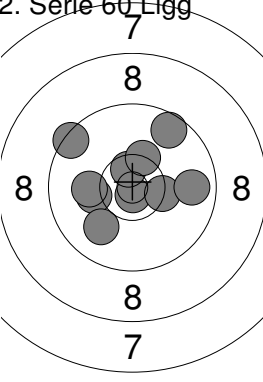
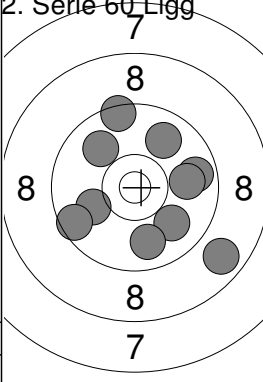
Prøve Ligg 	11: 9.8 → 12: 10.2 ↓ 13: 9.5 ↓ 14: 10.1 ↓ 15: 10.2 ↓ 16: 9.1 ↓ 17: 10.3 ↓ 18: 10.2 ← 19: 10.4x ↓ Serie 87.0 Total 190.0	2. Serie 60 Ligg 	1: 10.8x ↓ 2: 10.6x ↑ 3: 10.3x → 4: 10.2 ← 5: 9.8 → 6: 9.4 ↗ 7: 10.3x ↑ 8: 10.1 ← 9: 9.6 ↗ 10: 10.0 ↓ Serie 97.0 Total 287.0	2. Serie 60 Ligg 	11: 9.9 ↓ 12: 10.0 ← 13: 9.5 ↑ 14: 9.9 ↗ 15: 9.6 ← 16: 9.7 → 17: 9.9 ↗ 18: 9.8 ↓ 19: 8.8 ↓ 20: 9.9 → Serie 90.0 Total 377.0
--	---	---	---	---	--

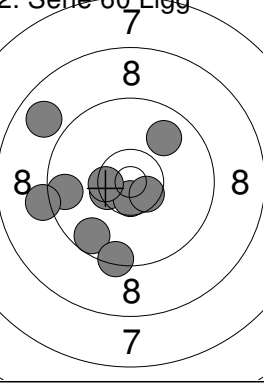
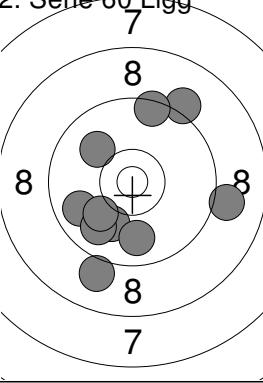
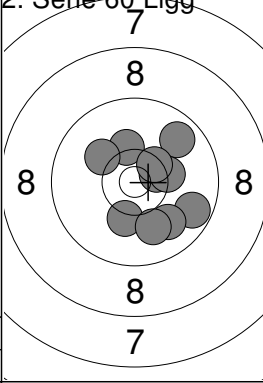
2. Serie 60 Ligg 	21: 9.6 ← 22: 9.2 ← 23: 10.4x ← 24: 8.8 ↗ 25: 10.6x ↓ 26: 9.7 ↓ 27: 10.5x ← 28: 10.6x → 29: 9.9 ↗ 30: 9.4 ↓ Serie 93.0 Total 470.0	2. Serie 60 Ligg 	31: 9.8 ← 32: 9.0 ↓ 33: 10.0 ↓ 34: 9.8 ↓ 35: 10.0 ↗ 36: 9.1 ↗ 37: 9.4 ↗ 38: 9.8 ↓ 39: 9.1 → 40: 10.1 ← Serie 93.0 Total 563.0	2. Serie 60 Ligg 	41: 9.7 → 42: 10.2 ↑ 43: 9.8 ↗ 44: 10.2 ↓ 45: 9.9 ↓ 46: 10.1 ↗ 47: 10.5x → 48: 10.3x → 49: 10.4x ↗ 50: 10.0 ↓ Serie 97.0 Total 660.0
--	---	---	--	---	---

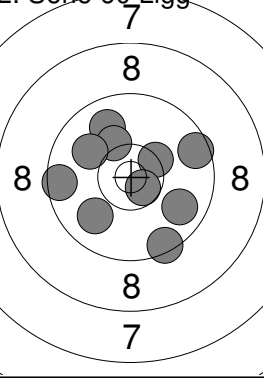
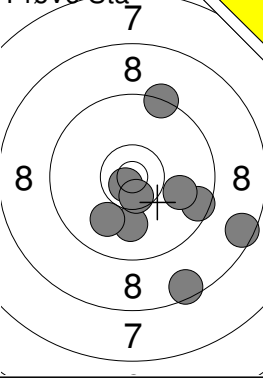
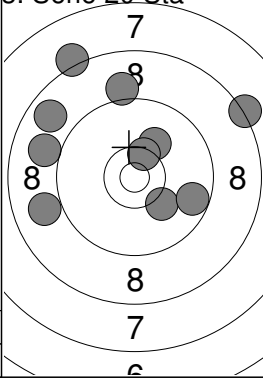
2. Serie 60 Ligg 	51: 9.6 → 52: 9.9 ↓ 53: 9.9 ↗ 54: 9.5 ← 55: 10.4x → 56: 9.8 → 57: 10.2 ↗ 58: 9.5 ↓ 59: 10.6x ↓ 60: 10.0 ↗ Serie 94.0 Total 754.0	Prøve Stå 	1: 8.5 ↓ 2: 8.5 → 3: 10.0 ↓ 4: 9.5 → 5: 9.3 ↗ 6: 10.0 → 7: 10.7x ↓ 8: 10.0 ↓ 9: 10.6x ↓ Serie 84.0 Total 754.0	3. Serie 20 Stå 	1: 9.1 ↑ 2: 9.0 ← 3: 9.0 ← 4: 8.8 ↗ 5: 10.2 ↓ 6: 10.1 ↗ 7: 9.7 → 8: 8.2 ↗ 9: 8.3 ↗ 10: 10.4x ↑ Serie 90.0 Total 844.0
--	---	--	--	--	--

3. Serie 20 Stå

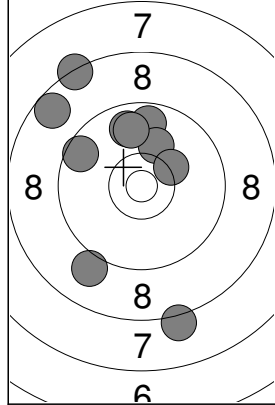

11:	8.6	↖
12:	8.3	↖
13:	9.8	↑
14:	9.7	↑
15:	10.1	↑
16:	9.0	↙
17:	8.2	↙
18:	10.3	↗
19:	9.6	↖
20:	9.8	↑
Serie	89.0	
Total	933.0	

--	--	--

--	--	--

--	--	--

--	--	--

--	--	--

--	--	--

--	--	--

--	--	--

--	--	--

--	--	--

--	--	--

--	--	--

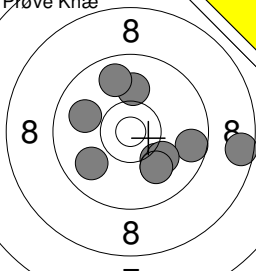
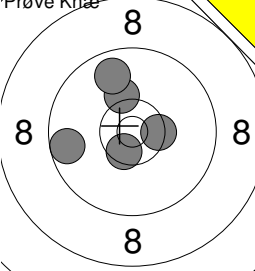
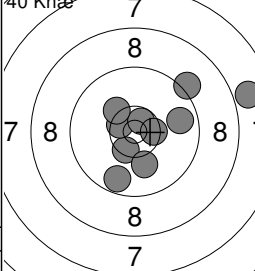
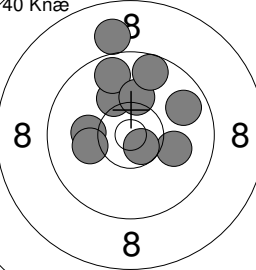
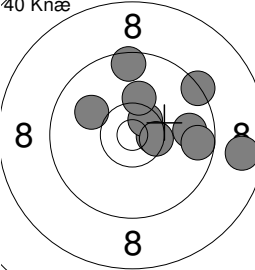
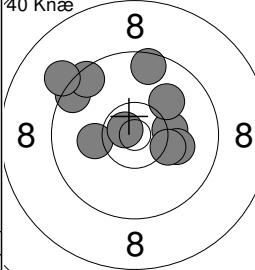
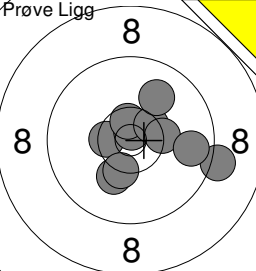
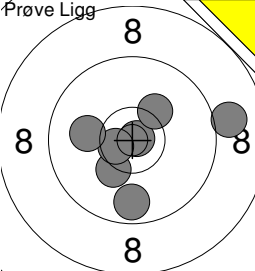
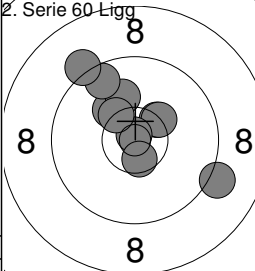
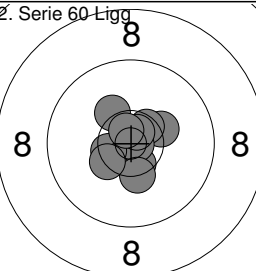
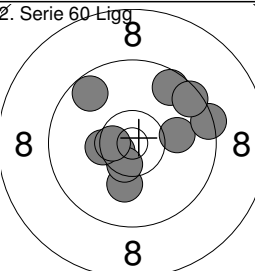
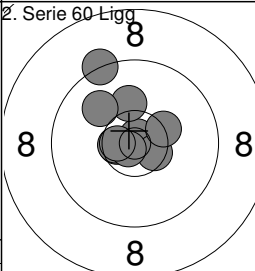
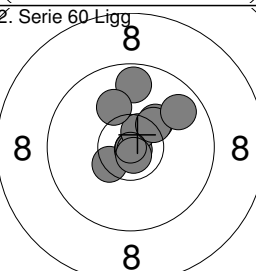
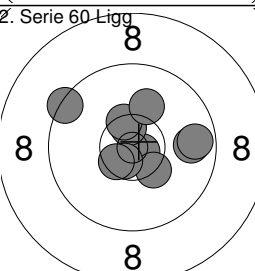
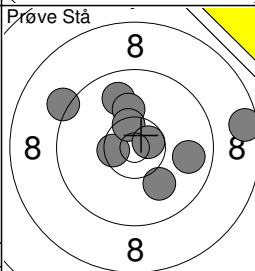
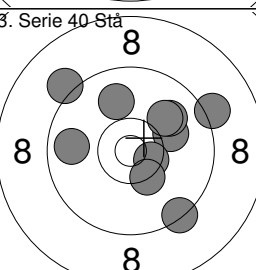
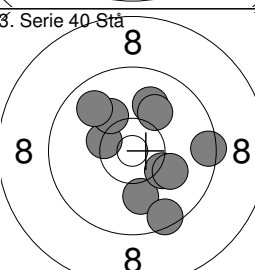
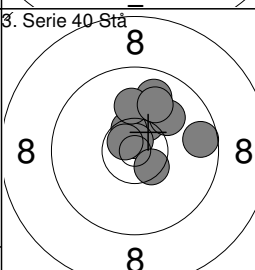
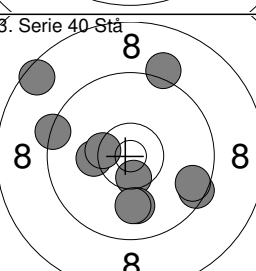
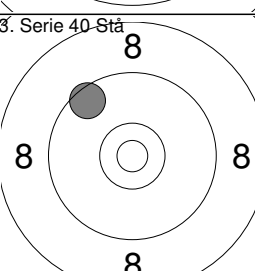
Prøve Knæ 	1: 9.9 2: 8.6 3: 9.6 4: 10.1 5: 10.0 6: 10.1 7: 10.1 8: 9.8 9: 9.9 10: 10.0 Serie 94.0 Total 0.0	Prøve Knæ 	11: 10.4x 12: 10.2 13: 9.8 14: 9.6 15: 10.5x Serie 48.0 Total 0.0	40 Knæ 	1: 9.7 2: 10.4x 3: 10.5x 4: 9.8 5: 10.6x 6: 10.5x 7: 10.1 8: 10.2 9: 9.2 10: 7.9 Serie 94.0 Total 94.0
40 Knæ 	11: 10.2 12: 9.0 13: 10.1 14: 10.1 15: 9.7 16: 10.2 17: 9.8 18: 10.6x 19: 10.1 20: 9.7 Serie 96.0 Total 190.0	40 Knæ 	21: 10.5x 22: 10.6x 23: 10.0 24: 9.4 25: 9.5 26: 10.2 27: 10.5x 28: 8.8 29: 9.8 30: 9.6 Serie 94.0 Total 284.0	40 Knæ 	31: 9.6 32: 10.3 33: 10.1 34: 10.1 35: 9.5 36: 10.2 37: 10.3 38: 10.7x 39: 9.5 40: 9.1 Serie 96.0 Total 380.0
Prøve Ligg 	1: 10.2 2: 10.5x 3: 10.8x 4: 10.6x 5: 10.5x 6: 9.2 7: 10.0 8: 10.3x 9: 10.3x 10: 9.7 Serie 98.0 Total 380.0	Prøve Ligg 	11: 9.0 12: 10.9x 13: 9.7 14: 10.3 15: 10.6x 16: 10.2 17: 10.1 Serie 68.0 Total 380.0	2. Serie 60 Ligg 	1: 10.4x 2: 10.2 3: 10.3x 4: 9.1 5: 10.1 6: 10.8x 7: 10.3x 8: 9.6 9: 9.2 10: 10.6x Serie 97.0 Total 477.0
2. Serie 60 Ligg 	11: 10.3x 12: 10.5x 13: 10.5x 14: 10.8x 15: 10.3 16: 10.5x 17: 10.3x 18: 10.4x 19: 10.7x 20: 10.7x Serie 100.0 Total 577.0	2. Serie 60 Ligg 	21: 10.1 22: 10.1 23: 9.6 24: 10.6x 25: 9.7 26: 9.4 27: 10.5x 28: 10.4x 29: 9.5 30: 10.6x Serie 96.0 Total 673.0	2. Serie 60 Ligg 	31: 10.6x 32: 10.8x 33: 10.5x 34: 10.2 35: 10.6x 36: 10.8x 37: 10.6x 38: 10.3x 39: 10.0 40: 9.3 Serie 99.0 Total 772.0
2. Serie 60 Ligg 	41: 9.7 42: 10.2 43: 10.4x 44: 10.9x 45: 10.9x 46: 10.6x 47: 10.8x 48: 10.1 49: 10.3x 50: 9.8 Serie 98.0 Total 870.0	2. Serie 60 Ligg 	51: 10.7x 52: 10.6x 53: 10.4x 54: 10.1 55: 10.3x 56: 9.8 57: 9.7 58: 9.4 59: 10.6x 60: 10.5x Serie 97.0 Total 967.0	Prøve Stå 	1: 10.5x 2: 8.6 3: 9.9 4: 10.1 5: 9.8 6: 9.2 7: 10.0 8: 10.5x 9: 10.6x Serie 85.0 Total 967.0
3. Serie 40 Stå 	1: 9.1 2: 9.8 3: 9.4 4: 10.1 5: 9.2 6: 10.0 7: 9.9 8: 10.5x 9: 10.3x 10: 10.0 Serie 95.0 Total 1062.0	3. Serie 40 Stå 	11: 9.4 12: 10.0 13: 10.0 14: 10.4x 15: 9.5 16: 10.1 17: 10.2 18: 10.1 19: 10.1 20: 9.8 Serie 97.0 Total 1159.0	3. Serie 40 Stå 	21: 10.4x 22: 10.5x 23: 10.8x 24: 10.5x 25: 9.8 26: 10.0 27: 10.7x 28: 10.1 29: 9.6 30: 10.0 Serie 98.0 Total 1257.0
3. Serie 40 Stå 	31: 10.5x 32: 9.5 33: 10.0 34: 10.2 35: 9.6 36: 8.5 37: 10.4x 38: 10.0 39: 9.3 40: 9.2 Serie 94.0 Total 1351.0	3. Serie 40 Stå 	41: 9.6 Serie 9.0 Total 1360.0		

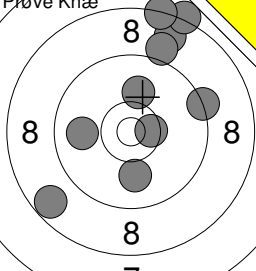
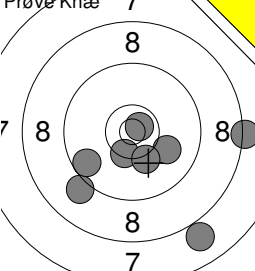
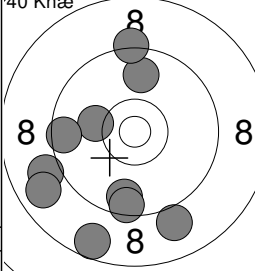
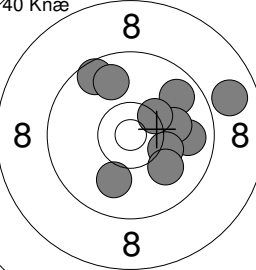
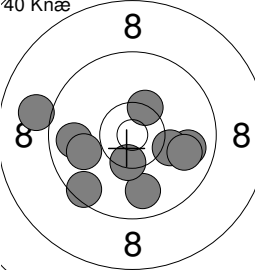
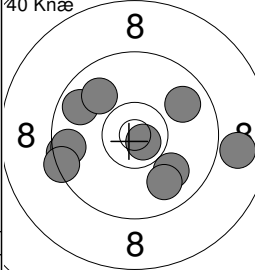
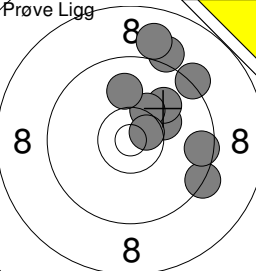
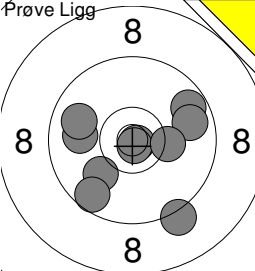
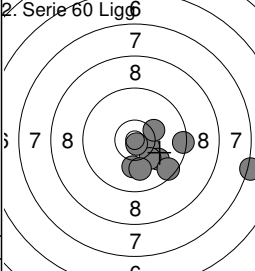
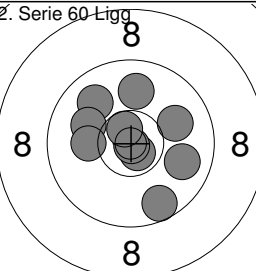
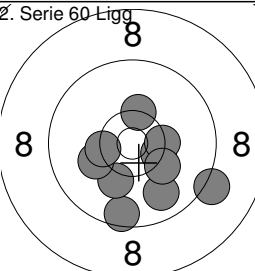
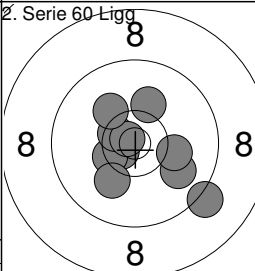
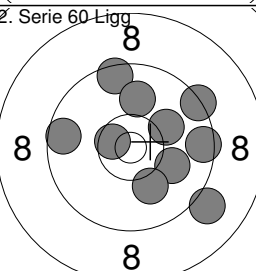
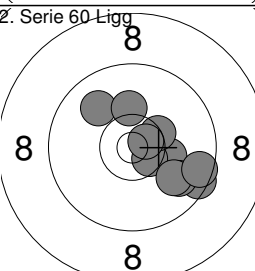
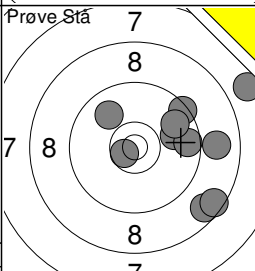
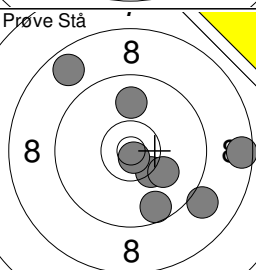
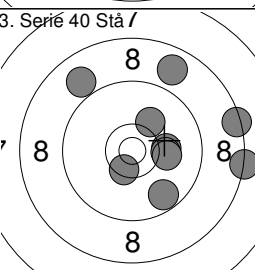
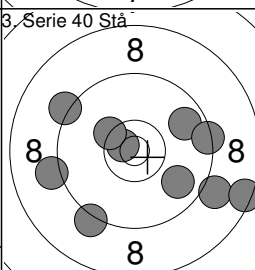
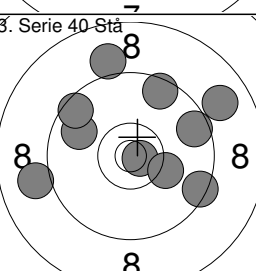
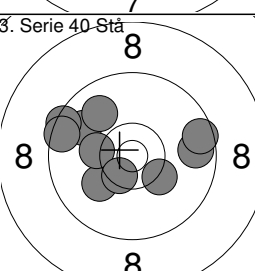
Prøve Knæ 	1: 8.7 ↗ 2: 10.1 ↗ 3: 10.0 ↘ 4: 9.3 ↘ 5: 10.5x → 6: 9.9 ← 7: 8.8 ↗ 8: 8.3 ↗ 9: 9.0 ↗ 10: 8.3 ↗ Serie 89.0 Total 0.0	Prøve Knæ / 	11: 10.4x ↘ 12: 8.3 → 13: 10.7x ↗ 14: 10.0 → 15: 8.0 ↘ 16: 10.2 ↘ 17: 9.1 ↘ 18: 9.6 ↘ Serie 74.0 Total 0.0	40 Knæ 	1: 8.6 ↘ 2: 10.2 ↘ 3: 9.7 ↘ 4: 9.0 ↘ 5: 8.8 ↘ 6: 9.6 ↘ 7: 9.0 ↘ 8: 9.5 ↘ 9: 9.8 ↘ 10: 9.3 ↘ Serie 89.0 Total 89.0
40 Knæ 	11: 9.6 ↗ 12: 9.8 ↗ 13: 9.8 ↗ 14: 10.0 ↗ 15: 8.9 → 16: 9.8 → 17: 10.1 → 18: 10.2 → 19: 10.3x → 20: 10.0 → Serie 94.0 Total 183.0	40 Knæ 	21: 9.8 ↘ 22: 9.8 ↘ 23: 10.4x ↗ 24: 9.8 → 25: 9.5 ↘ 26: 10.2 ↘ 27: 10.4x ↘ 28: 9.9 ↘ 29: 9.0 ↘ 30: 9.9 ↘ Serie 93.0 Total 276.0	40 Knæ 	31: 9.8 ↗ 32: 10.7x ↘ 33: 9.7 ↗ 34: 9.5 ↗ 35: 9.6 ↗ 36: 8.9 ↗ 37: 10.0 ↗ 38: 9.9 ↗ 39: 9.4 ↗ 40: 9.9 ↗ Serie 91.0 Total 367.0
Prøve Ligg 	1: 9.1 ↗ 2: 10.2 ↗ 3: 8.9 ↗ 4: 9.3 ↗ 5: 10.0 ↗ 6: 10.3 ↗ 7: 10.0 ↗ 8: 9.3 ↘ 9: 10.6x ↘ 10: 9.5 ↘ Serie 94.0 Total 367.0	Prøve Ligg 	11: 10.9x ↘ 12: 9.9 ↘ 13: 10.0 ↘ 14: 9.7 ↘ 15: 9.8 ↘ 16: 9.8 ↘ 17: 9.6 ↘ 18: 9.2 ↘ 19: 10.8x ↘ 20: 10.3 ↘ Serie 94.0 Total 367.0	2. Serie 60 Ligg 	1: 10.5x ↗ 2: 7.2 → 3: 9.4 → 4: 10.1 ↘ 5: 10.3 ↘ 6: 10.0 ↘ 7: 10.2 ↘ 8: 10.0 ↘ 9: 10.8x ↘ 10: 9.6 ↘ Serie 95.0 Total 462.0
2. Serie 60 Ligg 	11: 9.9 ↗ 12: 9.9 ↗ 13: 10.0 ↗ 14: 10.7x ↗ 15: 9.6 ↗ 16: 10.0 ↗ 17: 10.9x ↗ 18: 10.1 ↗ 19: 10.6x ↗ 20: 9.9 ↗ Serie 96.0 Total 558.0	2. Serie 60 Ligg 	21: 10.4x ↗ 22: 9.2 ↘ 23: 10.4x ↗ 24: 9.6 ↘ 25: 9.8 ↘ 26: 10.1 ↗ 27: 10.3x ↗ 28: 10.2 ↗ 29: 10.2 ↗ 30: 10.4x ↗ Serie 97.0 Total 655.0	2. Serie 60 Ligg 	31: 10.6x ↗ 32: 10.1 ↗ 33: 10.4x ↗ 34: 10.0 ↗ 35: 10.5x ↗ 36: 10.8x ↗ 37: 10.1 ↗ 38: 9.2 ↗ 39: 10.2 ↗ 40: 10.2 ↗ Serie 99.0 Total 754.0
2. Serie 60 Ligg 	41: 9.5 ↗ 42: 10.6x ↗ 43: 10.1 ↗ 44: 9.4 ↗ 45: 9.1 ↗ 46: 9.6 ↗ 47: 9.5 ↗ 48: 10.1 ↗ 49: 10.0 ↗ 50: 10.1 ↗ Serie 95.0 Total 849.0	2. Serie 60 Ligg 	51: 9.5 ↗ 52: 10.2 ↗ 53: 9.9 ↗ 54: 10.5x ↗ 55: 9.8 ↗ 56: 9.9 ↗ 57: 9.6 ↗ 58: 10.4x ↗ 59: 10.7x ↗ 60: 10.2 ↗ Serie 95.0 Total 944.0	Prøve Stå 	1: 8.9 ↗ 2: 8.7 ↗ 3: 10.6x ↗ 4: 9.4 ↗ 5: 9.9 ↗ 6: 8.5 ↗ 7: 9.6 ↗ 8: 9.9 ↗ 9: 7.7 ↗ 10: 9.8 ↗ Serie 86.0 Total 944.0
Prøve Stå 	11: 8.6 → 12: 9.9 ↗ 13: 9.6 ↗ 14: 10.3x ↗ 15: 8.7 ↗ 16: 10.1 ↗ 17: 10.8x ↗ 18: 9.0 ↗ Serie 73.0 Total 944.0	3. Serie 40 Stå / 	1: 10.5x ↘ 2: 8.8 ↘ 3: 8.9 ↘ 4: 9.7 ↘ 5: 10.1 ↘ 6: 8.4 ↘ 7: 10.2 ↘ 8: 10.1 ↘ 9: 8.3 ↘ 10: 10.1 ↘ Serie 91.0 Total 1035.0	3. Serie 40 Stå 	11: 9.0 ↗ 12: 8.4 ↗ 13: 9.8 ↗ 14: 9.2 ↗ 15: 10.7x ↗ 16: 9.7 ↗ 17: 10.3x ↗ 18: 9.2 ↗ 19: 9.4 ↗ 20: 9.1 ↗ Serie 91.0 Total 1126.0
3. Serie 40 Stå 	21: 9.8 ↗ 22: 9.6 ↗ 23: 9.0 ↗ 24: 10.8x ↗ 25: 9.0 ↗ 26: 9.5 ↗ 27: 9.4 ↗ 28: 10.2 ↗ 29: 8.9 ↗ 30: 9.5 ↗ Serie 91.0 Total 1217.0	3. Serie 40 Stå 	31: 9.8 ↗ 32: 9.7 ↗ 33: 9.5 ↗ 34: 9.6 ↗ 35: 10.1 ↗ 36: 10.3 ↗ 37: 9.5 ↗ 38: 10.2 ↗ 39: 9.9 ↗ 40: 10.5x ↗ Serie 94.0 Total 1311.0		

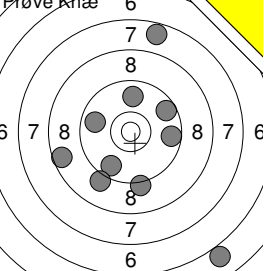
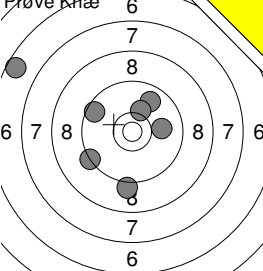
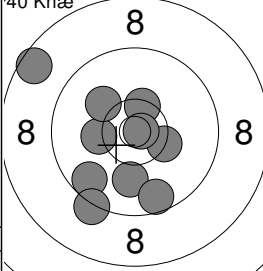
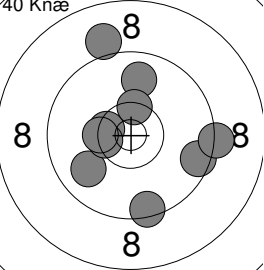
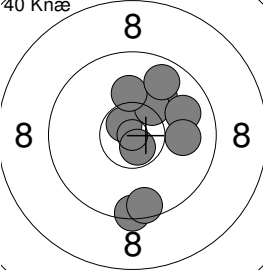
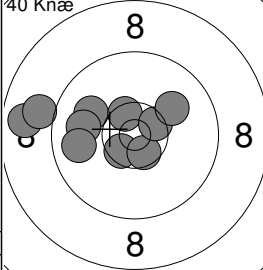
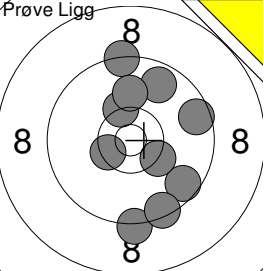
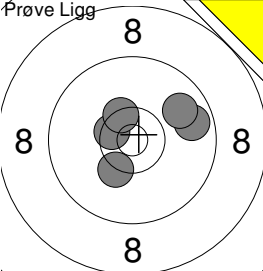
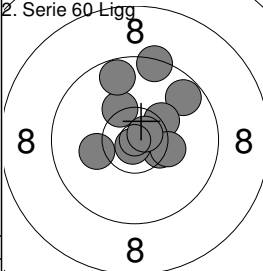
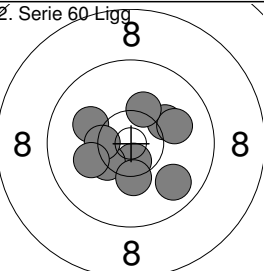
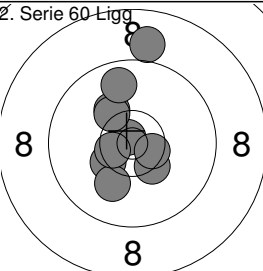
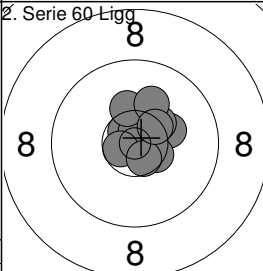
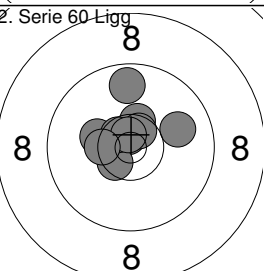
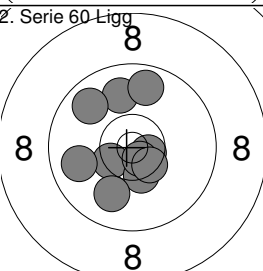
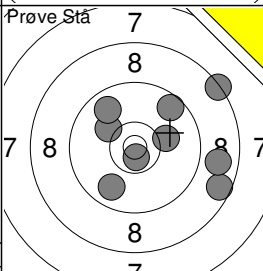
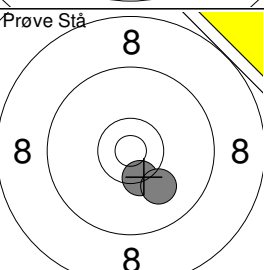
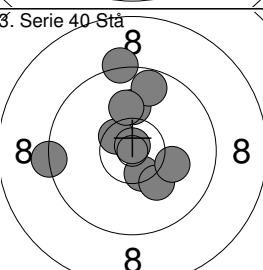
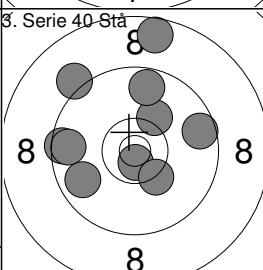
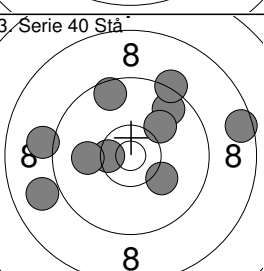
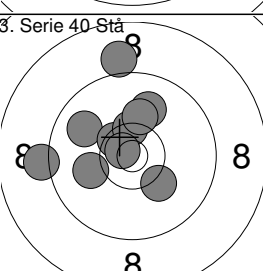
 <p>Prøve Knæ 6</p>	<p>1: 7.7 ↑ 2: 6.0 ↓ 3: 9.7 ↓ 4: 9.2 ↓ 5: 9.6 → 6: 9.6 → 7: 9.8 → 8: 8.6 ← 9: 9.1 ← 10: 9.8 ←</p> <p>Serie 84.0 Total 0.0</p>	 <p>Prøve Knæ 6</p>	<p>11: 9.6 → 12: 9.1 ↓ 13: 9.3 ↓ 14: 6.6 ↓ 15: 9.8 ↓ 16: 10.2 → 17: 10.0 →</p> <p>Serie 62.0 Total 0.0</p>	 <p>40 Knæ</p>	<p>1: 9.7 ↓ 2: 10.4x ↑ 3: 10.3x ↓ 4: 8.6 → 5: 10.0 ↓ 6: 10.2 ← 7: 9.2 ← 8: 10.1 ↓ 9: 10.8x ↓ 10: 9.6 ←</p> <p>Serie 95.0 Total 95.0</p>
 <p>40 Knæ</p>	<p>11: 9.6 → 12: 9.9 ↓ 13: 10.5x → 14: 9.3 → 15: 10.4x ← 16: 9.5 ↓ 17: 9.8 ↓ 18: 10.4x ↑ 19: 9.0 ← 20: 10.4x ←</p> <p>Serie 94.0 Total 189.0</p>	 <p>40 Knæ</p>	<p>21: 10.7x ↑ 22: 9.4 ↓ 23: 10.0 ↓ 24: 9.6 ↓ 25: 10.3x → 26: 10.1 ↑ 27: 9.8 ↓ 28: 10.7x ↓ 29: 9.9 → 30: 10.0 →</p> <p>Serie 96.0 Total 285.0</p>	 <p>40 Knæ</p>	<p>31: 10.0 → 32: 8.8 ← 33: 10.5x ↓ 34: 10.6x ↓ 35: 10.5x ↑ 36: 9.9 ← 37: 9.8 ← 38: 10.5x ↑ 39: 10.0 → 40: 9.0 ←</p> <p>Serie 95.0 Total 380.0</p>
 <p>Prøve Ligg</p>	<p>1: 9.2 ↓ 2: 9.3 ↓ 3: 9.6 ↓ 4: 9.6 ↓ 5: 9.7 ↓ 6: 9.4 ↓ 7: 10.3x ↓ 8: 10.0 ↓ 9: 10.3x ↓ 10: 10.4x ↓</p> <p>Serie 94.0 Total 380.0</p>	 <p>Prøve Ligg</p>	<p>11: 9.7 → 12: 10.5x ← 13: 10.3 ← 14: 9.8 → 15: 10.4x →</p> <p>Serie 48.0 Total 380.0</p>	 <p>2. Serie 60 Ligg</p>	<p>1: 10.3 ↑ 2: 9.7 ↑ 3: 10.2 ← 4: 9.7 → 5: 10.3x ↑ 6: 10.4x ↓ 7: 10.3 → 8: 9.4 ↑ 9: 10.8x ↓ 10: 10.7x ↓</p> <p>Serie 97.0 Total 477.0</p>
 <p>2. Serie 60 Ligg</p>	<p>11: 10.2 → 12: 10.0 → 13: 10.1 → 14: 10.2 → 15: 10.6x ↓ 16: 10.4x ↓ 17: 10.3 ↓ 18: 10.4x ← 19: 9.8 ← 20: 10.1 ←</p> <p>Serie 99.0 Total 576.0</p>	 <p>2. Serie 60 Ligg</p>	<p>21: 10.8x ↑ 22: 10.2 ↑ 23: 10.2 ↑ 24: 9.8 → 25: 10.3x → 26: 10.1 → 27: 10.4x → 28: 10.5x → 29: 9.0 → 30: 10.5x →</p> <p>Serie 98.0 Total 674.0</p>	 <p>2. Serie 60 Ligg</p>	<p>31: 10.7x ↑ 32: 10.2 → 33: 10.3x → 34: 10.7x ↑ 35: 10.6x ← 36: 10.5x ← 37: 10.2 ↑ 38: 10.1 ↑ 39: 10.6x ↓ 40: 10.4x ↓</p> <p>Serie 100.0 Total 774.0</p>
 <p>2. Serie 60 Ligg</p>	<p>41: 10.4x ↑ 42: 10.3 → 43: 10.7x ↑ 44: 10.5x ↓ 45: 9.7 → 46: 10.6x ↑ 47: 10.0 → 48: 10.6x ↑ 49: 10.7x ↑ 50: 10.4x ←</p> <p>Serie 99.0 Total 873.0</p>	 <p>2. Serie 60 Ligg</p>	<p>51: 10.4x ↑ 52: 9.9 ↓ 53: 10.4x ↑ 54: 9.9 ← 55: 9.9 ← 56: 10.6x ↓ 57: 10.7x ↓ 58: 10.5x ↓ 59: 9.8 ↓ 60: 9.7 ↑</p> <p>Serie 95.0 Total 968.0</p>	 <p>Prøve Stå</p>	<p>1: 6.8 ↑ 2: 8.6 ↓ 3: 10.1 ↑ 4: 9.8 ↓ 5: 10.1 → 6: 8.8 ↓ 7: 9.6 ↓ 8: 9.8 ↓ 9: 8.4 ↓ 10: 10.7x ↓</p> <p>Serie 87.0 Total 968.0</p>
 <p>Prøve Stå</p>	<p>11: 10.4x ↓ 12: 10.1 ↓</p> <p>Serie 20.0 Total 968.0</p>	 <p>3. Serie 40 Stå</p>	<p>1: 9.3 ← 2: 10.5x ← 3: 10.1 ↑ 4: 10.5x ↓ 5: 10.2 ↓ 6: 9.3 ↓ 7: 9.7 → 8: 10.8x ↑ 9: 10.1 ↑ 10: 10.1 →</p> <p>Serie 97.0 Total 1065.0</p>	 <p>3. Serie 40 Stå</p>	<p>11: 9.1 ↑ 12: 9.6 → 13: 10.7x ↓ 14: 9.8 ↓ 15: 8.6 ↑ 16: 9.5 ← 17: 9.6 ← 18: 10.2 ↑ 19: 10.3 ↓ 20: 9.7 ↑</p> <p>Serie 92.0 Total 1157.0</p>
 <p>3. Serie 40 Stå</p>	<p>21: 10.1 → 22: 9.7 ↓ 23: 10.1 ↑ 24: 8.5 → 25: 9.6 → 26: 8.9 ↓ 27: 9.3 ↓ 28: 10.5x ↓ 29: 9.1 ← 30: 10.0 ←</p> <p>Serie 92.0 Total 1249.0</p>	 <p>3. Serie 40 Stå</p>	<p>31: 10.0 ↑ 32: 9.9 ↑ 33: 10.5x ↑ 34: 9.0 → 35: 10.4x ↑ 36: 10.1 ← 37: 9.2 ← 38: 10.7x ↓ 39: 10.2 ↓ 40: 10.2 ↑</p> <p>Serie 97.0 Total 1346.0</p>		

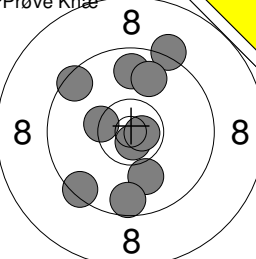
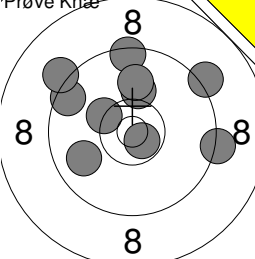
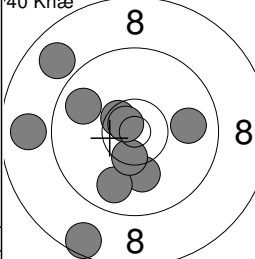
Prøve Knæ 	1: 9.5 ↖ 2: 9.2 ↗ 3: 10.7x ↘ 4: 9.8 ↖ 5: 10.0 ↘ 6: 10.4x ↗ 7: 10.7x ↖ 8: 9.8 ↗ 9: 9.4 ↘ 10: 9.6 ↖ Serie 94.0 Total 0.0	Prøve Knæ 	11: 10.7x ↖ 12: 9.9 ↗ 13: 9.5 ↘ 14: 9.4 ↖ 15: 9.3 ↗ 16: 10.3x ↘ 17: 10.1 ↖ 18: 9.2 ↗ 19: 9.2 ↘ 20: 10.0 ↖ Serie 94.0 Total 0.0	40 Knæ 	1: 10.1 ↘ 2: 8.6 ↖ 3: 9.8 ↗ 4: 8.8 ↖ 5: 10.4x ↘ 6: 8.9 ↖ 7: 10.5x ↗ 8: 9.8 ↘ 9: 10.7x ↖ 10: 9.9 ↗ Serie 91.0 Total 91.0
---	---	--	---	---	--

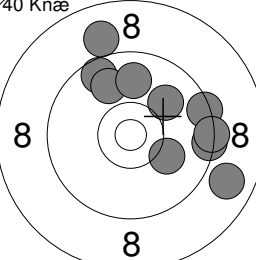
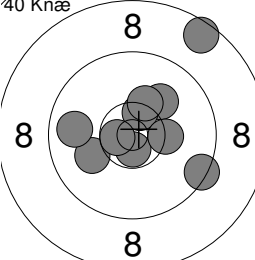
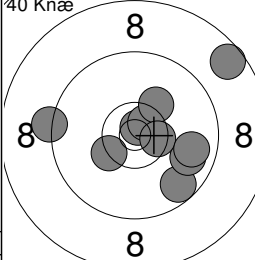
40 Knæ 	11: 10.1 ↖ 12: 9.0 ↗ 13: 9.4 ↘ 14: 10.0 ↖ 15: 8.9 ↗ 16: 9.6 ↘ 17: 9.4 ↖ 18: 9.9 ↗ 19: 9.9 ↘ 20: 9.4 ↖ Serie 91.0 Total 182.0	40 Knæ 	21: 10.1 ↖ 22: 9.4 ↗ 23: 10.1 ↘ 24: 8.6 ↖ 25: 10.5x ↗ 26: 10.7x ↘ 27: 10.3x ↖ 28: 10.6x ↗ 29: 9.8 ↘ 30: 10.3 ↖ Serie 96.0 Total 278.0	40 Knæ 	31: 10.8x ↖ 32: 10.6x ↗ 33: 8.6 ↘ 34: 9.3 ↖ 35: 9.7 ↗ 36: 10.3x ↘ 37: 10.2 ↖ 38: 9.8 ↗ 39: 10.5x ↘ 40: 9.8 ↖ Serie 94.0 Total 372.0
--	---	---	--	---	--

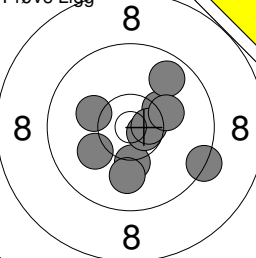
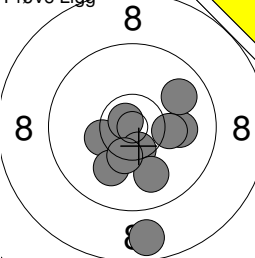
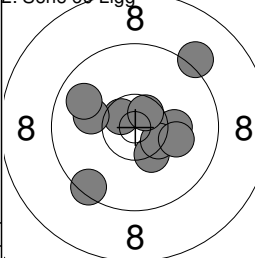
Prøve Ligg 	1: 10.2 ↖ 2: 10.2 ↗ 3: 10.3 ↘ 4: 9.8 ↖ 5: 10.0 ↗ 6: 10.1 ↘ 7: 10.7x ↖ 8: 10.6x ↗ 9: 10.2 ↘ 10: 9.3 ↖ Serie 98.0 Total 372.0	Prøve Ligg 	11: 10.3x ↖ 12: 10.0 ↗ 13: 10.8x ↘ 14: 10.0 ↖ 15: 8.8 ↗ 16: 10.5x ↘ 17: 9.9 ↖ 18: 10.0 ↗ 19: 10.4x ↘ 20: 10.2 ↖ Serie 97.0 Total 372.0	2. Serie 60 Ligg 	1: 10.6x ↖ 2: 10.2 ↗ 3: 10.3x ↘ 4: 9.2 ↖ 5: 10.4x ↗ 6: 10.6x ↘ 7: 9.5 ↖ 8: 10.1 ↗ 9: 9.8 ↘ 10: 10.1 ↖ Serie 97.0 Total 469.0
---	--	--	---	--	---

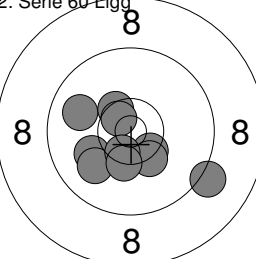
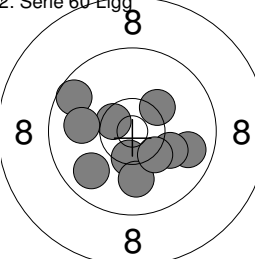
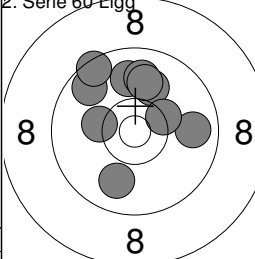
2. Serie 60 Ligg 	11: 9.9 ↖ 12: 10.4x ↗ 13: 10.1 ↘ 14: 10.0 ↖ 15: 10.6x ↗ 16: 10.4x ↘ 17: 10.3x ↖ 18: 10.5x ↗ 19: 9.2 ↘ 20: 10.3x ↖ Serie 98.0 Total 567.0	2. Serie 60 Ligg 	21: 9.8 ↖ 22: 9.8 ↗ 23: 10.3 ↘ 24: 10.1 ↖ 25: 9.6 ↗ 26: 10.5x ↘ 27: 10.4x ↖ 28: 10.0 ↗ 29: 9.9 ↘ 30: 10.3x ↖ Serie 96.0 Total 663.0	2. Serie 60 Ligg 	31: 10.0 ↖ 32: 9.8 ↗ 33: 9.9 ↘ 34: 9.7 ↖ 35: 10.2 ↗ 36: 9.5 ↘ 37: 9.9 ↖ 38: 9.9 ↗ 39: 10.3x ↘ 40: 10.0 ↖ Serie 94.0 Total 757.0
--	---	---	--	---	--

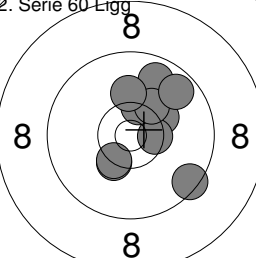
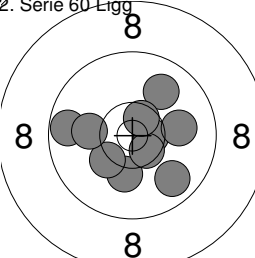
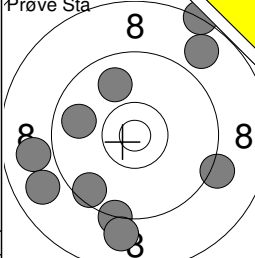
2. Serie 60 Ligg 	41: 10.3 ↖ 42: 10.5x ↗ 43: 10.3x ↘ 44: 10.4x ↖ 45: 9.8 ↗ 46: 10.2 ↘ 47: 9.7 ↖ 48: 10.1 ↗ 49: 9.5 ↘ 50: 10.4x ↖ Serie 97.0 Total 854.0	2. Serie 60 Ligg 	51: 10.2 ↖ 52: 10.6x ↗ 53: 10.3 ↘ 54: 10.0 ↖ 55: 10.5x ↗ 56: 9.9 ↘ 57: 9.8 ↖ 58: 9.7 ↗ 59: 10.1 ↘ 60: 10.6x ↖ Serie 97.0 Total 951.0	Prøve Stå 	1: 9.8 ↖ 2: 8.8 ↗ 3: 8.3 ↘ 4: 9.9 ↖ 5: 8.9 ↗ 6: 9.3 ↘ 7: 8.9 ↖ 8: 9.6 ↗ 9: 9.2 ↘ 10: 9.0 ↖ Serie 86.0 Total 951.0
--	--	---	---	--	--

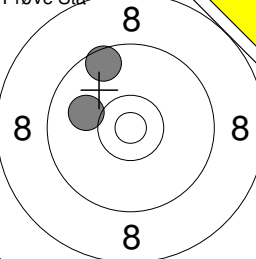
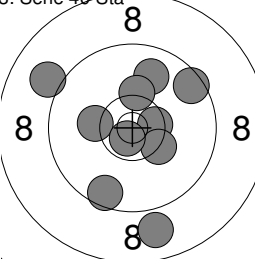
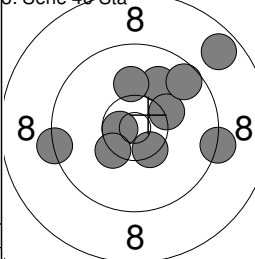
Prøve Stå 	11: 10.0 ↖ 12: 9.6 ↗ Serie 19.0 Total 951.0	3. Serie 40 Stå 	1: 9.5 ↖ 2: 9.9 ↗ 3: 9.6 ↘ 4: 8.9 ↖ 5: 10.5x ↗ 6: 10.2 ↘ 7: 10.3 ↖ 8: 10.3x ↗ 9: 9.0 ↘ 10: 10.7x ↖ Serie 94.0 Total 1045.0	3. Serie 40 Stå 	11: 10.0 ↖ 12: 10.6x ↗ 13: 10.3x ↘ 14: 10.3 ↖ 15: 9.3 ↗ 16: 8.7 ↘ 17: 10.1 ↖ 18: 9.6 ↗ 19: 10.4x ↘ 20: 9.3 ↖ Serie 95.0 Total 1140.0
---	--	--	---	--	---

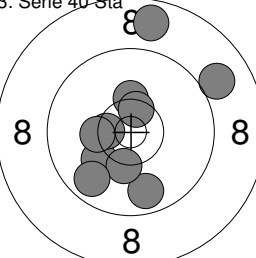
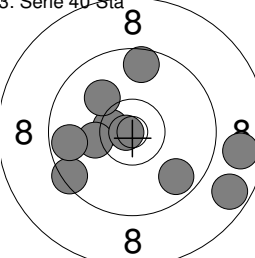
3. Serie 40 Stå 	21: 9.0 ↖ 22: 10.1 ↗ 23: 9.8 ↘ 24: 10.3x ↖ 25: 10.5x ↗ 26: 10.3 ↘ 27: 9.8 ↖ 28: 10.5x ↗ 29: 8.8 ↘ 30: 10.3x ↖ Serie 95.0 Total 1235.0	3. Serie 40 Stå 	31: 10.5x ↖ 32: 10.1 ↗ 33: 9.4 ↘ 34: 9.6 ↖ 35: 8.7 ↗ 36: 10.2 ↘ 37: 10.8x ↖ 38: 9.7 ↗ 39: 9.7 ↘ 40: 8.8 ↖ Serie 92.0 Total 1327.0
---	--	--	--

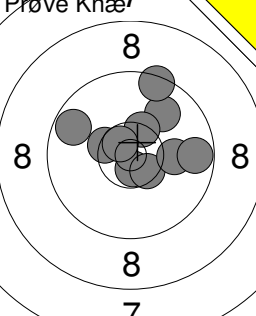
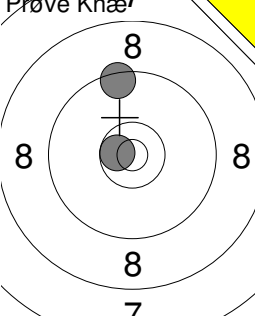
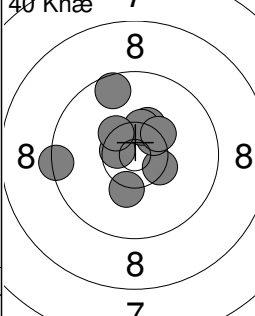
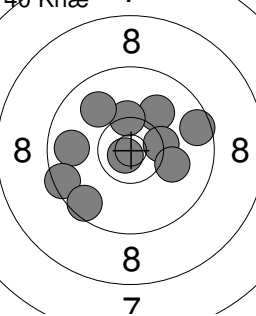
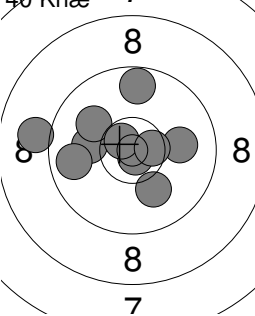
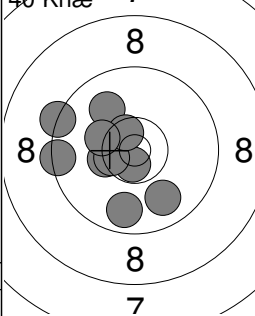
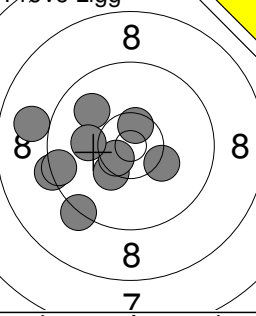
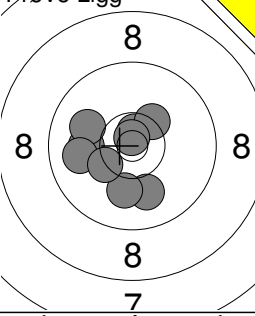
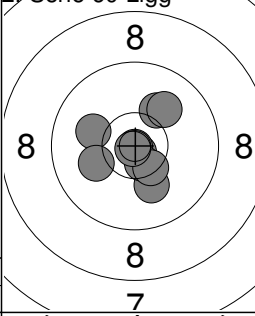
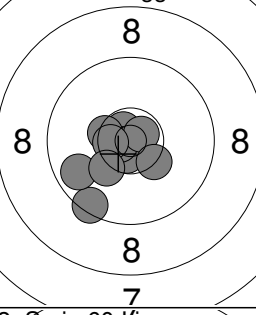
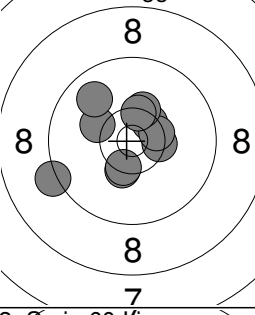
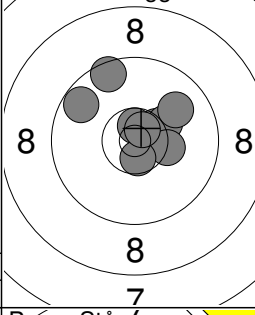
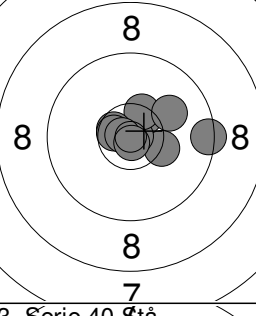
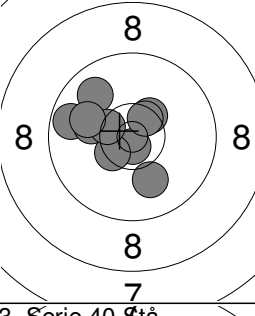
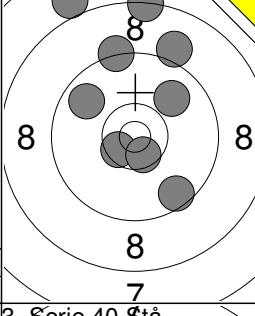
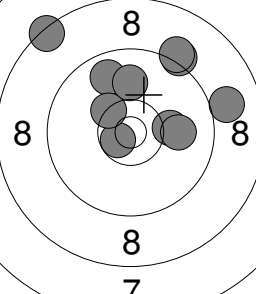
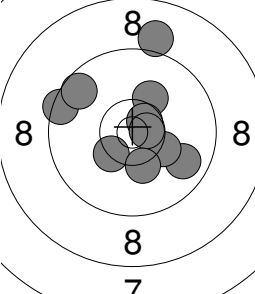
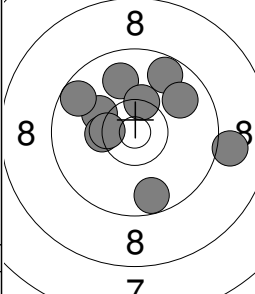
Prøve Knæl 	1: 10.7x ↓ 2: 10.5x ↓ 3: 10.1 → 4: 10.4x ← 5: 9.9 ↗ 6: 9.5 ↗ 7: 9.7 ↗ 8: 10.4x ↗ 9: 10.6x ↗ 10: 9.7 → Serie 96.0 Total 0.0	Prøve Knæl 	11: 9.5 ↑ 12: 10.7x ← Serie 19.0 Total 0.0	40 Knæ 	1: 9.6 ↗ 2: 10.4x ↘ 3: 10.6x ← 4: 10.3x ↗ 5: 10.4x ↗ 6: 9.4 ← 7: 10.4x ↗ 8: 10.3x ↗ 9: 10.4x ↗ 10: 10.3 ↓ Serie 98.0 Total 98.0
40 Knæ 	11: 9.8 ← 12: 10.1 → 13: 9.6 ↗ 14: 10.8x ↓ 15: 9.5 ← 16: 10.3x → 17: 9.6 ↓ 18: 10.1 → 19: 10.3x ↗ 20: 9.9 ↗ Serie 95.0 Total 193.0	40 Knæ 	21: 10.1 ← 22: 9.8 ← 23: 9.0 ← 24: 10.8x ↓ 25: 10.0 ↗ 26: 10.0 → 27: 10.7x ↗ 28: 9.7 ↗ 29: 10.6x ↗ 30: 10.1 ↓ Serie 97.0 Total 290.0	40 Knæ 	31: 9.4 ← 32: 10.3x ← 33: 10.0 ↗ 34: 10.7x ↓ 35: 9.8 ↓ 36: 10.5x ← 37: 9.9 ↓ 38: 10.6x ↗ 39: 10.3 ↗ 40: 9.3 ↗ Serie 96.0 Total 386.0
Prøve Ligg 	1: 10.5x ↑ 2: 9.0 ← 3: 10.3x ↓ 4: 9.3 ← 5: 10.6x ↓ 6: 9.3 ↓ 7: 9.5 ← 8: 9.9 ↗ 9: 10.1 ← 10: 10.3 ← Serie 95.0 Total 386.0	Prøve Ligg 	11: 10.7x ↑ 12: 10.0 ← 13: 10.0 ↓ 14: 10.3x ↓ 15: 10.0 ↗ 16: 10.1 ↓ 17: 10.8x ↑ 18: 9.9 ← 19: 10.3x ← Serie 89.0 Total 386.0	2. Serie 60 Ligg 	1: 10.1 ↗ 2: 10.1 ← 3: 10.1 ↓ 4: 10.8x ↓ 5: 10.9x ↓ 6: 10.6x ↓ 7: 10.4x ↓ 8: 10.1 ← 9: 10.9x ↗ 10: 10.0 ↗ Serie 100.0 Total 486.0
2. Serie 60 Ligg 	11: 10.7x ↓ 12: 10.7x ↗ 13: 9.5 ↓ 14: 10.7x ← 15: 10.4x ← 16: 10.7x ↗ 17: 10.6x ↗ 18: 9.8 ← 19: 10.3x ↘ 20: 10.2 ↓ Serie 98.0 Total 584.0	2. Serie 60 Ligg 	21: 10.2 ↗ 22: 10.4x → 23: 9.8 ↗ 24: 10.3x ↓ 25: 10.4x ↗ 26: 10.4x → 27: 10.3x ↗ 28: 10.4x ↗ 29: 9.2 ← 30: 10.4x ↑ Serie 98.0 Total 682.0	2. Serie 60 Ligg 	31: 10.4x ↗ 32: 10.4x → 33: 9.7 ↗ 34: 10.3 ↗ 35: 10.7x ↗ 36: 10.3x → 37: 10.6x ↓ 38: 9.9 ↗ 39: 10.7x ↗ 40: 9.5 ↗ Serie 97.0 Total 779.0
2. Serie 60 Ligg 	41: 10.5x ↗ 42: 10.3x → 43: 10.9x → 44: 10.4x ↗ 45: 10.6x ↘ 46: 9.4 → 47: 10.1 ↗ 48: 10.6x ← 49: 10.8x ↗ 50: 10.8x ↓ Serie 99.0 Total 878.0	2. Serie 60 Ligg 	51: 9.9 ↗ 52: 9.7 ↗ 53: 10.4x ↗ 54: 10.8x ↓ 55: 10.5x ↘ 56: 10.0 ↓ 57: 10.1 ↗ 58: 10.5x ↗ 59: 10.4x ↗ 60: 10.0 ↗ Serie 98.0 Total 976.0	Prøve Stå 	1: 8.0 ↗ 2: 9.3 ↗ 3: 8.3 ↗ 4: 9.8 ↗ 5: 10.5x ↘ 6: 9.6 ↓ 7: 10.6x ↓ 8: 9.1 ↗ 9: 9.9 ↗ Serie 81.0 Total 976.0
3. Serie 40 Stå 	1: 9.8 ↗ 2: 8.4 ↗ 3: 9.2 ↗ 4: 10.7x ↘ 5: 10.3x ↘ 6: 10.0 ↗ 7: 9.2 ↗ 8: 10.2 → 9: 10.0 → 10: 9.0 → Serie 94.0 Total 1070.0	3. Serie 40 Stå 	11: 10.2 ↗ 12: 10.6x ↗ 13: 9.1 ↗ 14: 9.8 ↘ 15: 10.3 ↘ 16: 9.5 ↗ 17: 10.4x ↗ 18: 10.7x → 19: 9.6 ↗ 20: 10.3 ↓ Serie 96.0 Total 1166.0	3. Serie 40 Stå 	21: 9.9 ↗ 22: 9.7 ↗ 23: 10.2 ↗ 24: 9.9 ↗ 25: 10.3x ← 26: 10.4x ← 27: 9.6 ↗ 28: 9.0 → 29: 10.3x ↗ 30: 9.7 ↓ Serie 94.0 Total 1260.0

3. Serie 40 Sta

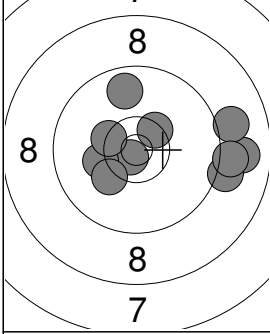

- 31: 8.9 →
- 32: 10.4x ↗
- 33: 9.0 →
- 34: 9.8 ↑
- 35: 10.8x ↙
- 36: 10.2 ←
- 37: 9.2 →
- 38: 10.2 ↙
- 39: 9.1 →
- 40: 10.4x ↖

Serie	94.0
Total	1354.0

<p>Prøve</p>	<p>1: 9.7 → 2: 8.9 ↓ 3: 10.4x ↓ 4: 10.0 ↑ 5: 9.7 ↓ 6: 9.3 → 7: 9.3 ← 8: 10.6x ↓ 9: 10.7x ↑ 10: 9.8 ↑</p>	<p>Prøve</p>	<p>11: 10.5x ← 12: 10.4x ← 13: 9.2 ↓ 14: 9.3 ↓ 15: 10.2 → 16: 9.9 ↑ 17: 9.3 ↓ 18: 10.1 ←</p>
Serie 98.4		Serie 78.9	
Total 0.0		Total 0.0	

<p>40 Skud</p>	<p>1: 10.4x ↑ 2: 10.2 → 3: 9.3 → 4: 10.5x ↗ 5: 10.0 ↓ 6: 10.3x ← 7: 10.3x ← 8: 9.6 ↖ 9: 9.5 ← 10: 8.4 ↓</p>	<p>40 Skud</p>	<p>11: 9.6 ↗ 12: 8.9 ↗ 13: 9.5 → 14: 10.5x → 15: 10.6x ↑ 16: 10.2 ↓ 17: 10.0 ← 18: 9.6 ↓ 19: 10.1 ↓ 20: 9.7 ←</p>
Serie 98.5		Serie 98.7	
Total 98.5		Total 197.2	

<p>40 Skud</p>	<p>21: 10.1 ← 22: 8.2 ↑ 23: 10.0 ← 24: 9.9 ↓ 25: 10.2 ↓ 26: 9.7 → 27: 10.6x ↗ 28: 10.0 ↑ 29: 10.2 ↖ 30: 9.4 ↓</p>	<p>40 Skud</p>	<p>31: 8.3 ← 32: 10.2 ↖ 33: 9.8 → 34: 8.7 ↑ 35: 10.2 ← 36: 10.8x ← 37: 9.1 ↗ 38: 9.1 ↗ 39: 10.3 ↓ 40: 9.6 ↖</p>
Serie 98.3		Serie 96.1	
Total 295.5		Total 391.6	

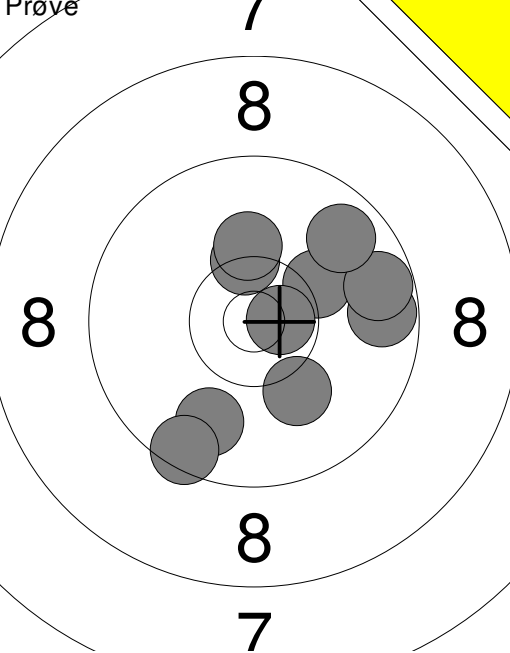
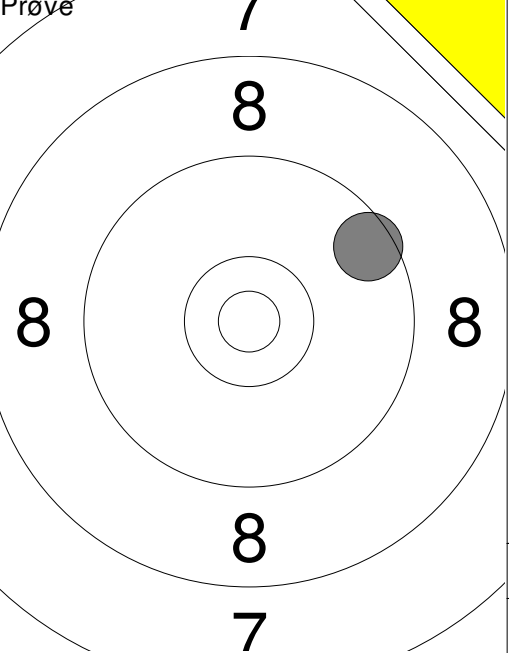
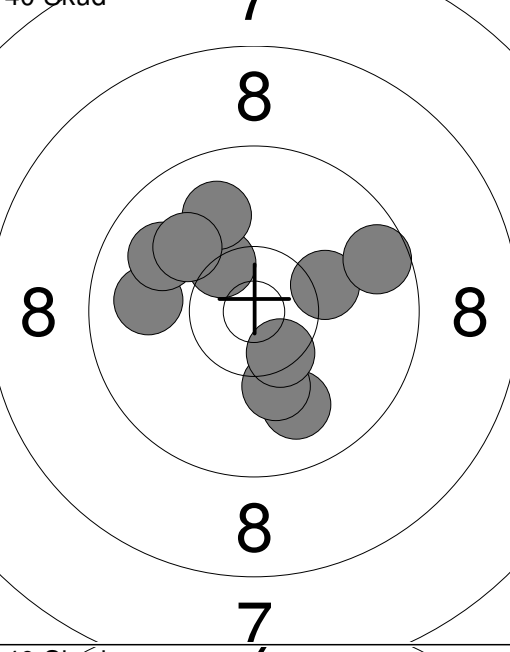
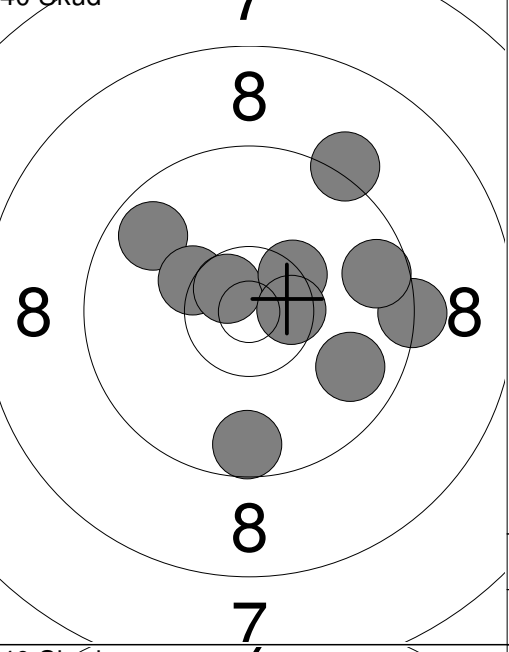
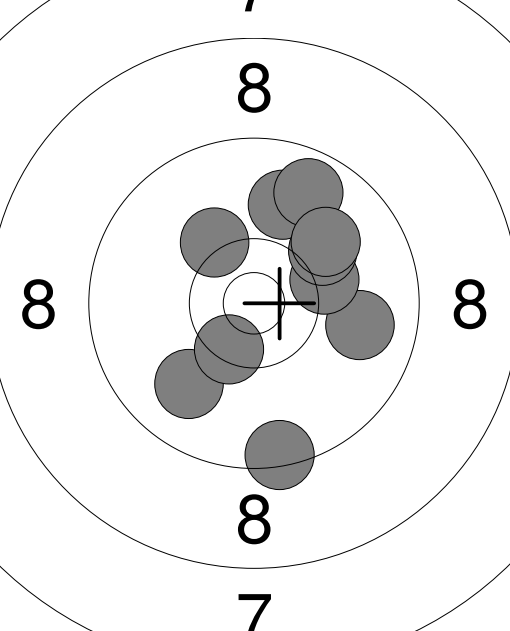
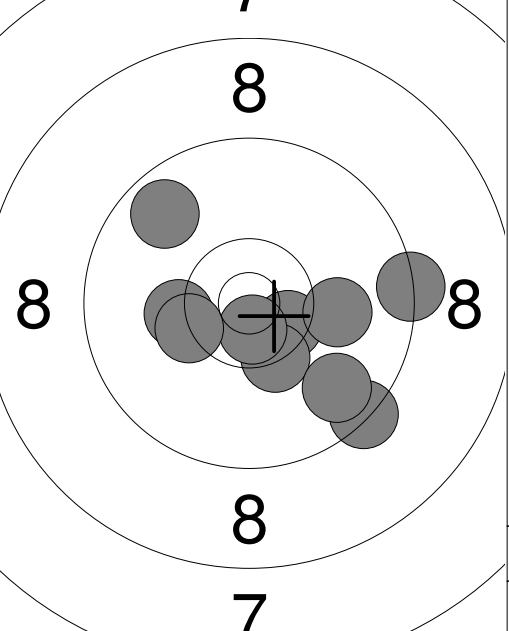
Prøve 	1: 9.7 → 2: 10.3x ↑ 3: 10.2 ↑ 4: 10.2 ↗ 5: 9.7 → 6: 10.7x → 7: 10.1 ↓ 8: 9.8 ↗ 9: 9.9 ↓ 10: 9.5 ↓ <hr/> Serie 100.1 Total 0.0	Prøve 	11: 9.5 ↗ <hr/> Serie 9.5 Total 0.0
40 Skud 	1: 10.4x ↗ 2: 9.9 ↓ 3: 10.2 ↓ 4: 9.9 ← 5: 9.9 ↗ 6: 10.2 → 7: 9.6 → 8: 9.9 ↑ 9: 10.0 ↗ 10: 10.5x ↓ <hr/> Serie 100.5 Total 100.5	40 Skud 	11: 9.7 ↖ 12: 9.2 ↗ 13: 9.8 ↘ 14: 10.3x ↖ 15: 10.6x ↖ 16: 10.4x ↗ 17: 9.3 → 18: 9.6 → 19: 9.6 ↓ 20: 10.5x → <hr/> Serie 99.0 Total 199.5
40 Skud 	21: 10.2 ↖ 22: 9.9 → 23: 10.2 → 24: 9.9 ↑ 25: 9.7 ↑ 26: 10.1 ↗ 27: 9.9 ↓ 28: 10.4x ↓ 29: 9.4 ↓ 30: 10.0 ↗ <hr/> Serie 99.7 Total 299.2	40 Skud 	31: 10.5x ↘ 32: 9.7 ↖ 33: 9.3 → 34: 10.3x ↓ 35: 10.7x ↓ 36: 10.1 → 37: 10.2 ← 38: 9.4 ↓ 39: 9.7 ↓ 40: 10.3x ↖ <hr/> Serie 100.2 Total 399.4

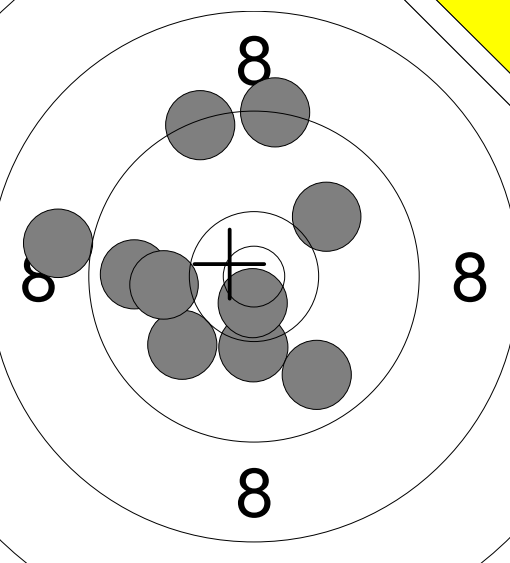
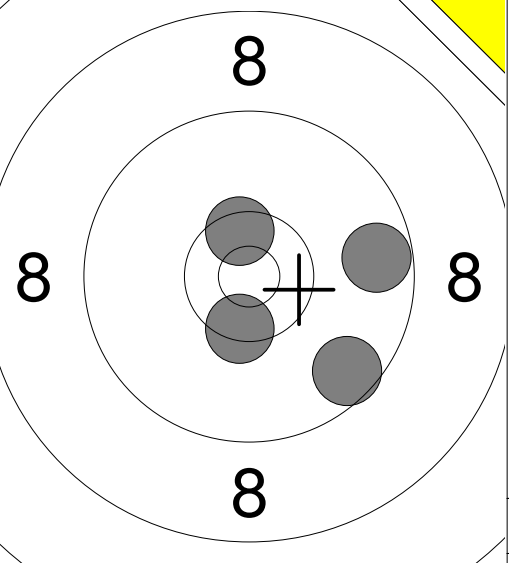
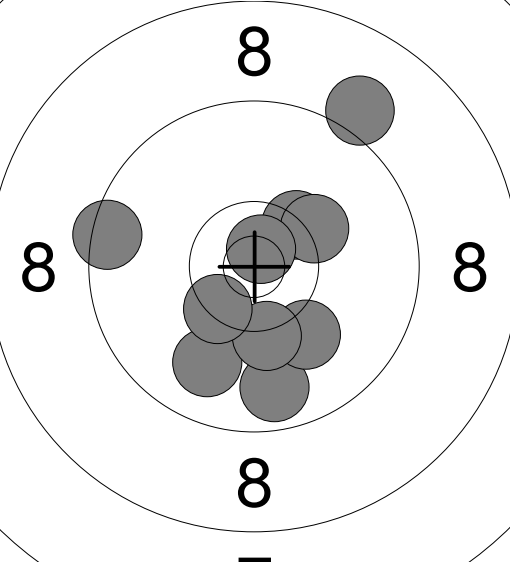
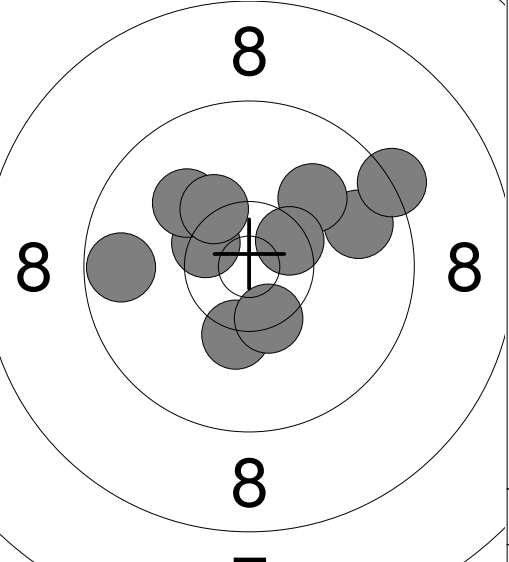
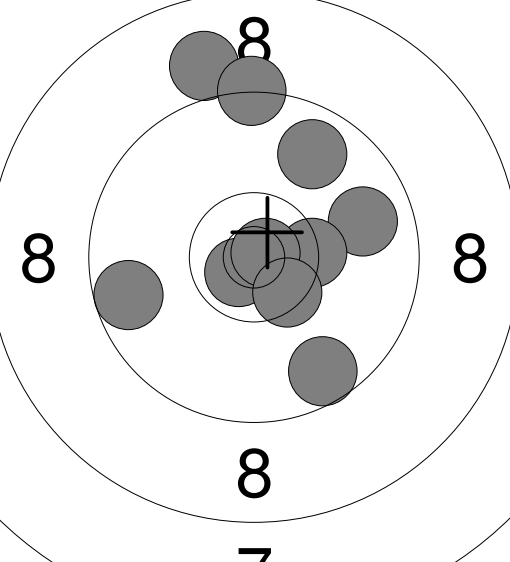
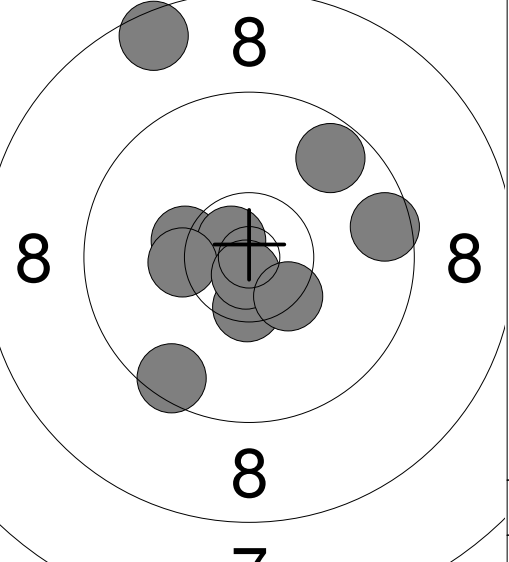
Prøve  <p style="text-align: center; font-size: 2em; font-weight: bold;">7</p>	1: 9.8 ← 2: 9.0 ← 3: 9.3 ↑ 4: 9.3 ↑ 5: 10.0 ↙ 6: 10.2 ↓ 7: 10.0 ↗ 8: 9.8 ↘ 9: 10.7x ↓ 10: 10.1 ← <hr/> Serie 98.2 Total 0.0	Prøve  <p style="text-align: center; font-size: 2em; font-weight: bold;">7</p>	11: 10.4x ↓ 12: 9.7 → 13: 9.6 ↘ 14: 10.5x ↑ <hr/> Serie 40.2 Total 0.0
40 Skud  <p style="text-align: center; font-size: 2em; font-weight: bold;">7</p>	1: 10.4x ↗ 2: 9.9 ↘ 3: 9.7 ↘ 4: 10.1 ↘ 5: 10.2 ↘ 6: 9.1 ↗ 7: 10.4x ↘ 8: 9.5 ← 9: 10.2 ↗ 10: 10.8x ↑ <hr/> Serie 100.3 Total 100.3	40 Skud  <p style="text-align: center; font-size: 2em; font-weight: bold;">7</p>	11: 10.5x ↖ 12: 9.8 → 13: 10.3 ↓ 14: 10.1 ↖ 15: 10.4x ↓ 16: 10.0 ↗ 17: 10.3 ↖ 18: 10.5x ↗ 19: 9.7 ← 20: 9.3 ↗ <hr/> Serie 100.9 Total 201.2
40 Skud  <p style="text-align: center; font-size: 2em; font-weight: bold;">7</p>	21: 9.8 → 22: 9.0 ↑ 23: 9.8 ↑ 24: 9.3 ↑ 25: 9.6 ↘ 26: 10.7x ↘ 27: 10.4x → 28: 10.8x → 29: 9.6 ← 30: 10.5x ↘ <hr/> Serie 99.5 Total 300.7	40 Skud  <p style="text-align: center; font-size: 2em; font-weight: bold;">7</p>	31: 8.5 ↖ 32: 10.5x ↓ 33: 9.7 ↗ 34: 10.3x ↖ 35: 10.7x ↖ 36: 9.6 → 37: 10.3 ← 38: 10.8x ↓ 39: 10.4x ↘ 40: 9.5 ↘ <hr/> Serie 100.3 Total 401.0

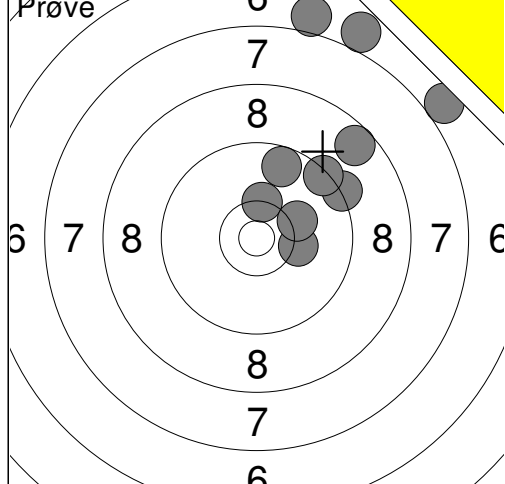

1:	7.0	↗
2:	9.3	→
3:	8.6	↗
4:	7.0	↗
5:	7.0	↑
6:	9.6	↑
7:	10.2	→
8:	10.3x	↑
9:	10.2	→
10:	9.4	↗
Serie		88.6
Total		0.0

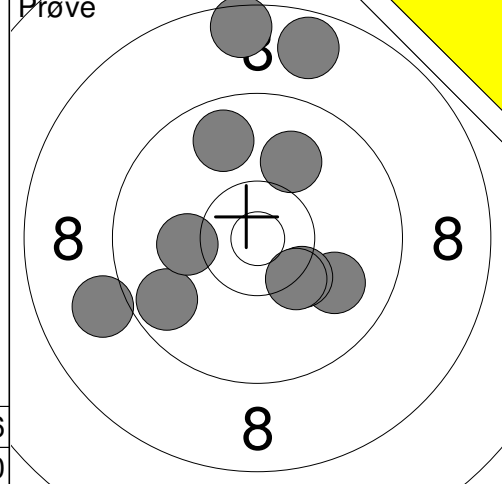

11:	8.7	↗
12:	9.9	→
13:	10.0	↑
14:	8.5	↑
15:	9.8	↑
16:	10.3	↘
17:	10.3x	↘
18:	9.7	↙
19:	9.0	↙
20:	10.1	←
Serie		96.3
Total		0.0

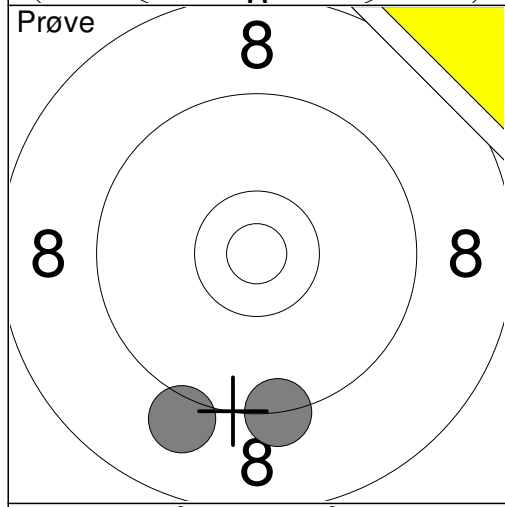

21:	9.3	↘
22:	9.1	↘
Serie		18.4
Total		0.0

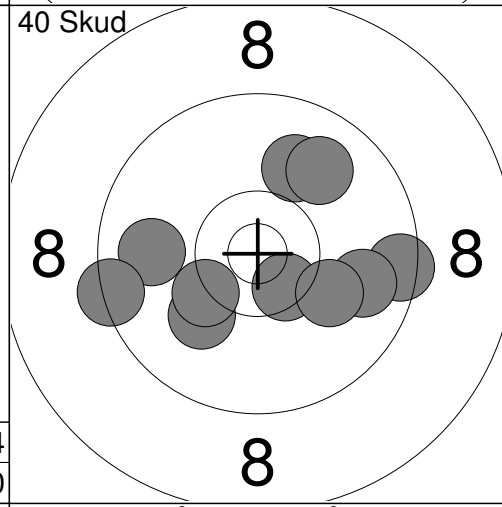

1:	10.1	↘
2:	9.5	→
3:	10.0	↑
4:	9.9	↗
5:	10.5x	↘
6:	9.9	←
7:	9.4	←
8:	9.8	→
9:	10.1	↘
10:	10.3	↙
Serie		99.5
Total		99.5

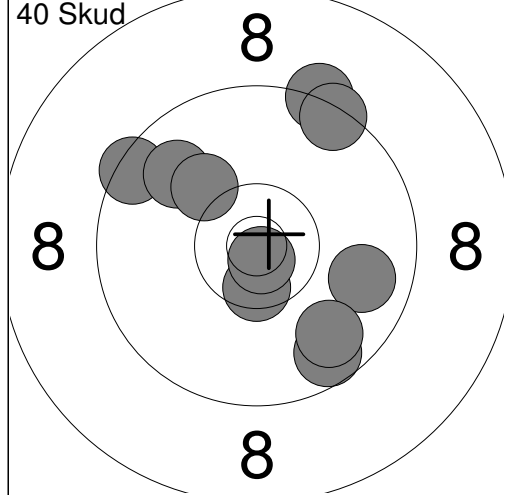

11:	9.8	→
12:	9.3	↑
13:	9.4	↑
14:	9.6	↘
15:	9.5	↗
16:	9.8	↗
17:	10.1	↗
18:	10.5x	↘
19:	10.8x	↘
20:	9.8	↘
Serie		98.6
Total		198.1

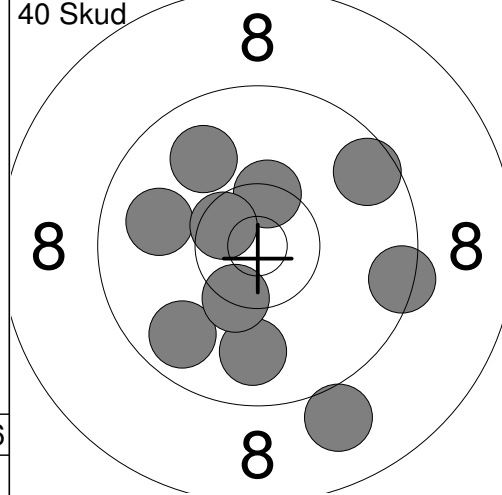

21:	9.8	↘
22:	9.9	↘
23:	9.9	←
24:	9.6	↗
25:	9.9	↗
26:	9.0	↘
27:	10.4x	↑
28:	10.5x	↖
29:	9.4	→
30:	10.4x	↘
Serie		98.8
Total		296.9

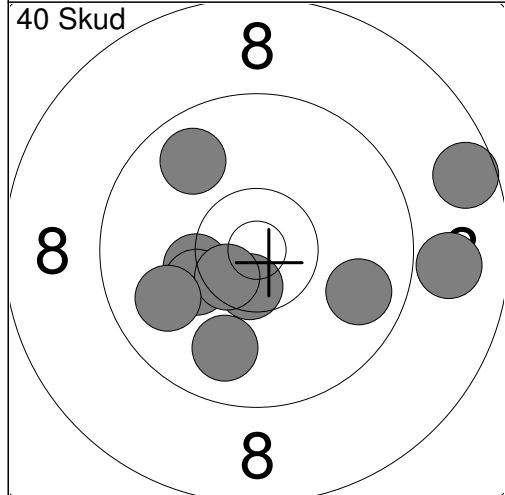

31:	10.3x	←
32:	9.9	↘
33:	9.8	↗
34:	10.6x	↘
35:	10.2	←
36:	10.5x	↙
37:	8.6	→
38:	9.9	←
39:	9.8	→
40:	8.9	→
Serie		98.5
Total		395.4

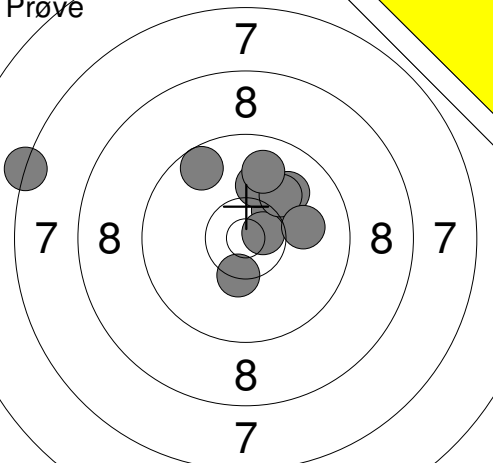
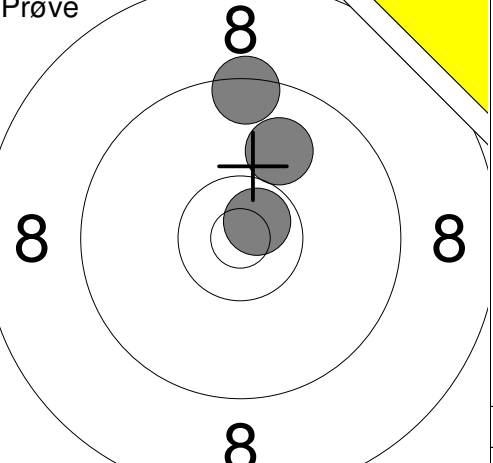
Prøve 	1: 7.3 ← 2: 10.3x ↓ 3: 10.3x ↗ 4: 10.0 ↗ 5: 10.1 ↑ 6: 9.6 ↗ 7: 10.7x → 8: 10.1 ↗ 9: 10.0 → 10: 9.9 ↑ Serie 98.3 Total 0.0	Prøve 	11: 10.7x ↗ 12: 9.4 ↑ 13: 10.0 ↑ Serie 30.1 Total 0.0
--	--	--	---

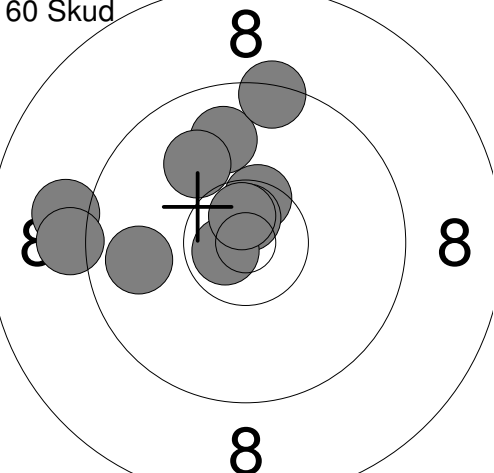
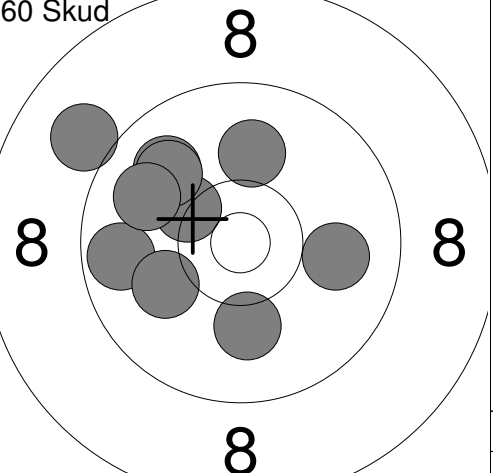
60 Skud 	1: 10.5x ↑ 2: 10.7x ↑ 3: 10.7x ← 4: 9.1 ← 5: 9.1 ← 6: 9.9 ↑ 7: 10.7x ↑ 8: 9.4 ↑ 9: 10.0 ↗ 10: 9.8 ← Serie 99.9 Total 99.9	60 Skud 	11: 10.1 ↓ 12: 10.0 → 13: 10.3x ↖ 14: 9.7 ← 15: 10.0 ↑ 16: 9.0 ↖ 17: 9.9 ↗ 18: 9.9 ↗ 19: 9.9 ↖ 20: 10.1 ↖ Serie 98.9 Total 198.8
---	--	---	---

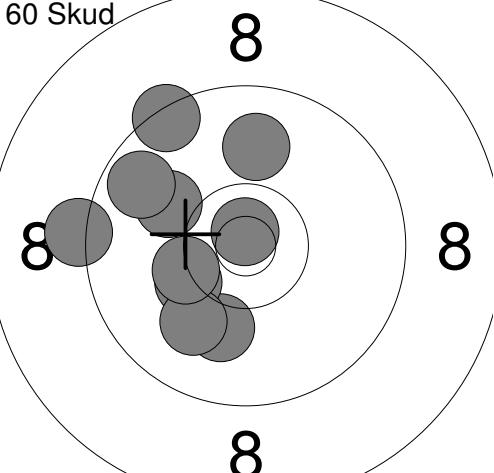
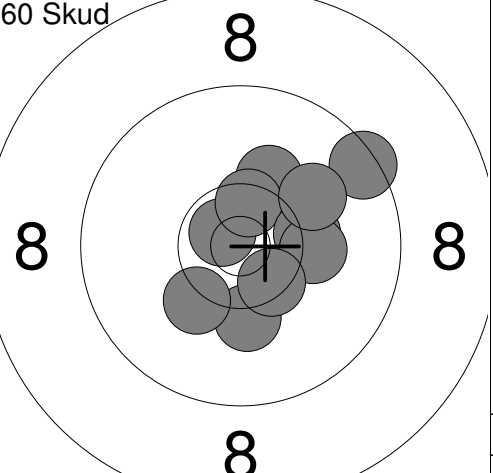
60 Skud 	21: 9.9 ↑ 22: 10.8x ↑ 23: 10.1 ↓ 24: 9.2 ← 25: 10.3 ↖ 26: 10.0 ↖ 27: 9.4 ↗ 28: 10.3 ← 29: 10.0 ↖ 30: 9.7 ↗ Serie 99.7 Total 298.5	60 Skud 	31: 9.4 ↗ 32: 10.2 ↑ 33: 10.7x ↖ 34: 10.5x ↑ 35: 10.3 → 36: 10.2 ↓ 37: 10.2 ↖ 38: 10.2 → 39: 10.5x ↘ 40: 10.1 ↗ Serie 102.3 Total 400.8
--	--	--	--

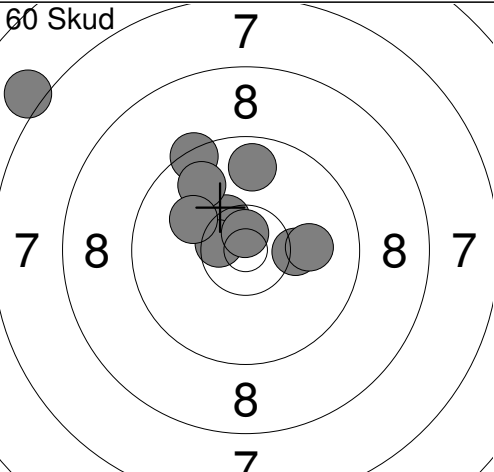
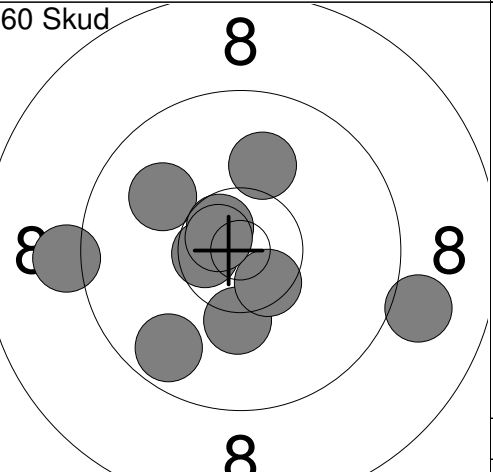
60 Skud 	41: 10.2 → 42: 10.0 → 43: 9.4 ↗ 44: 10.4x ↗ 45: 10.6x ↖ 46: 9.8 ↗ 47: 9.7 ↑ 48: 10.7x ↑ 49: 10.1 ↖ 50: 7.1 ↗ Serie 98.0 Total 498.8	60 Skud 	51: 10.0 ↖ 52: 10.6x ← 53: 10.0 ↑ 54: 10.2 ↓ 55: 9.0 → 56: 9.2 ← 57: 10.6x ↗ 58: 9.7 ↖ 59: 10.5x ↘ 60: 10.7x ↖ Serie 100.5 Total 599.3
--	--	--	---

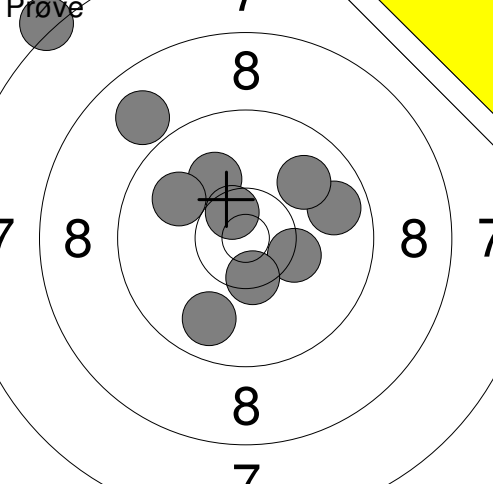
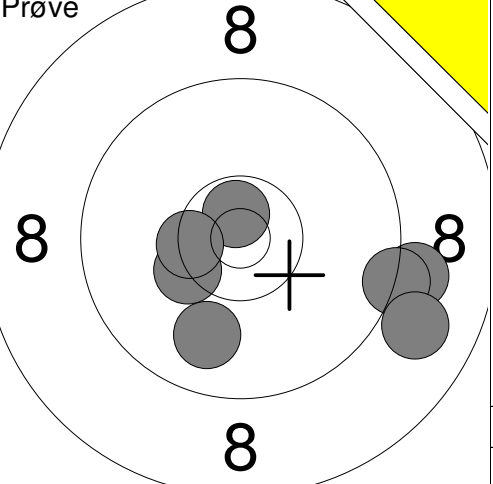
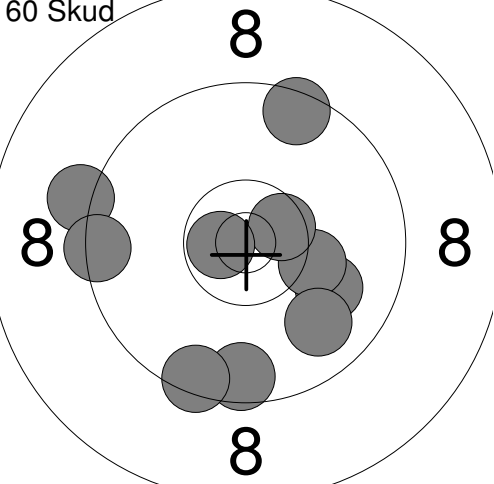
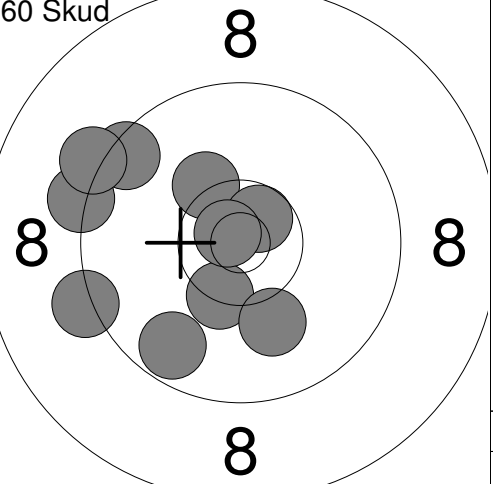
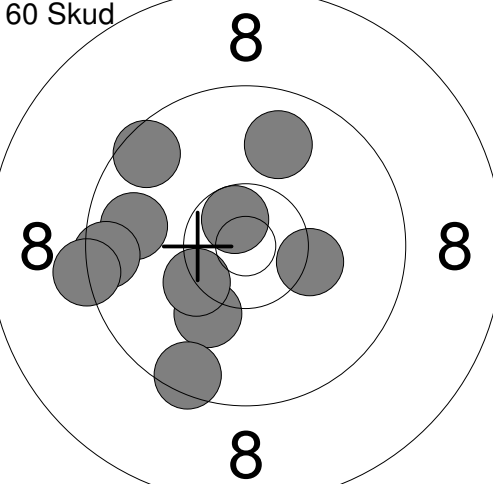
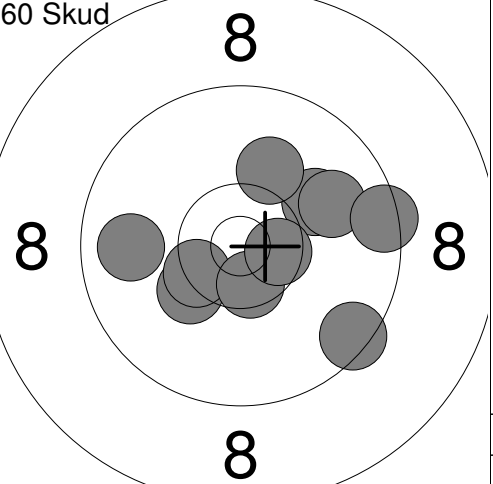
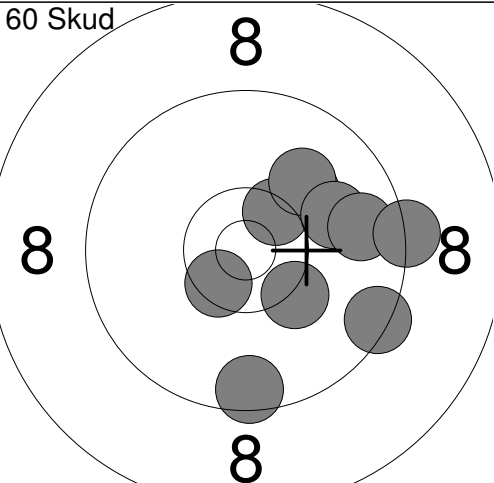
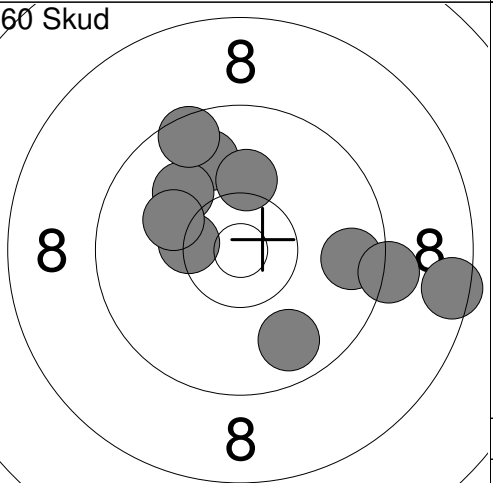
<p>Prøve</p>  <p style="text-align:center;">8</p>	<p>1: 7.2 ↗ 2: 9.8 → 3: 9.9 ↗ 4: 8.9 ↗ 5: 10.1 ↗ 6: 10.3x → 7: 10.4x ↓ 8: 9.8 ↓ 9: 10.0 ↗ 10: 10.6x ↗</p> <p>Serie 97.0 Total 0.0</p>	<p>Prøve</p>  <p style="text-align:center;">8</p>	<p>11: 9.1 → 12: 9.3 → 13: 9.9 ↓ 14: 10.7x ↑ 15: 10.3x ← 16: 10.4x ← 17: 8.9 →</p> <p>Serie 68.6 Total 0.0</p>
<p>60 Skud</p>  <p style="text-align:center;">8</p>	<p>1: 10.0 → 2: 9.5 ↑ 3: 10.2 → 4: 9.2 ← 5: 9.6 ↓ 6: 10.5x → 7: 9.5 ↓ 8: 9.4 ← 9: 9.8 ↓ 10: 10.7x ←</p> <p>Serie 98.4 Total 98.4</p>	<p>60 Skud</p>  <p style="text-align:center;">8</p>	<p>11: 9.5 ↖ 12: 10.4x ↓ 13: 10.1 ↓ 14: 10.3 ↗ 15: 9.2 ← 16: 9.2 ↖ 17: 10.6x ↗ 18: 10.8x ↖ 19: 9.7 ↓ 20: 9.2 ←</p> <p>Serie 99.0 Total 197.4</p>
<p>60 Skud</p>  <p style="text-align:center;">8</p>	<p>21: 9.6 ↖ 22: 9.8 ← 23: 10.1 ↓ 24: 10.7x ↑ 25: 10.3 → 26: 10.3x ← 27: 9.5 ← 28: 9.9 ↑ 29: 9.3 ← 30: 9.5 ↓</p> <p>Serie 99.0 Total 296.4</p>	<p>60 Skud</p>  <p style="text-align:center;">8</p>	<p>31: 9.8 ← 32: 10.3 ↖ 33: 10.4x ← 34: 10.5x ↓ 35: 9.5 ↘ 36: 10.1 ↗ 37: 9.9 ↗ 38: 10.6x → 39: 10.1 ↑ 40: 9.4 →</p> <p>Serie 100.6 Total 397.0</p>
<p>60 Skud</p>  <p style="text-align:center;">8</p>	<p>41: 10.3 ↘ 42: 9.4 → 43: 10.1 ↗ 44: 10.5x ↘ 45: 10.4x ↗ 46: 10.0 ↗ 47: 10.0 → 48: 9.7 → 49: 9.5 ↓ 50: 9.3 →</p> <p>Serie 99.2 Total 496.2</p>	<p>60 Skud</p>  <p style="text-align:center;">8</p>	<p>51: 9.9 ↑ 52: 9.8 ↓ 53: 8.5 → 54: 10.1 ↑ 55: 9.7 → 56: 10.0 ↗ 57: 10.4x ← 58: 10.1 ← 59: 9.5 ↑ 60: 9.2 →</p> <p>Serie 97.2 Total 593.4</p>

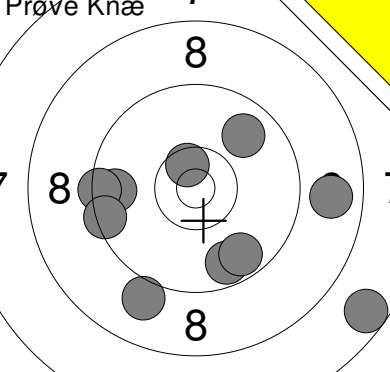
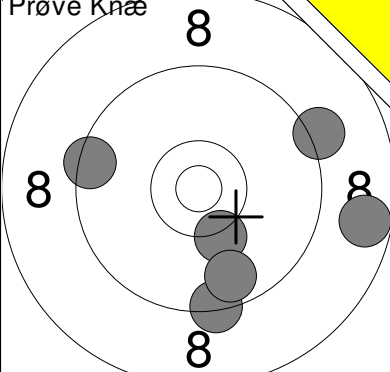
Prøve Knæ 	1: 9.0 ↘ 2: 8.8 → 3: 9.7 ← 4: 9.4 ← 5: 9.7 ↘ 6: 10.6x ↗ 7: 9.4 ← 8: 7.6 ↘ 9: 9.7 ↘ 10: 9.8 ↗ <hr/> Serie 88.0 Total 0.0	Prøve Knæ 	11: 9.5 ← 12: 10.2 ↘ 13: 9.3 ↘ 14: 9.7 ↘ 15: 8.7 → 16: 9.2 → <hr/> Serie 54.0 Total 0.0
--	--	--	--

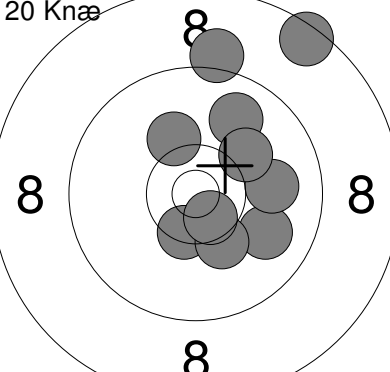
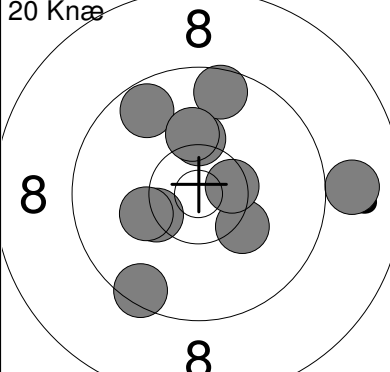
20 Knæ 	1: 9.1 ↑ 2: 8.5 ↗ 3: 9.9 ↘ 4: 10.4x ↘ 5: 10.2 ↗ 6: 9.9 ↗ 7: 10.0 → 8: 10.2 ↘ 9: 10.1 ↗ 10: 10.6x ↘ <hr/> Serie 95.0 Total 95.0	20 Knæ 	11: 10.2 ↑ 12: 10.2 ↘ 13: 10.3x ← 14: 9.7 ↗ 15: 8.9 → 16: 9.5 ↘ 17: 10.2 ← 18: 10.5x → 19: 9.6 ↑ 20: 10.2 ↑ <hr/> Serie 95.0 Total 190.0
---	---	---	---

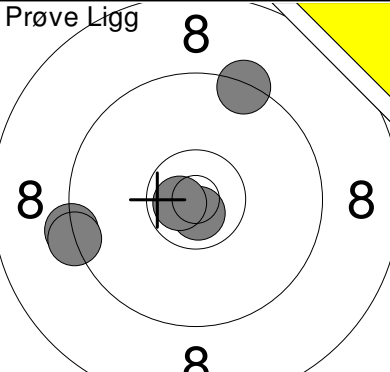
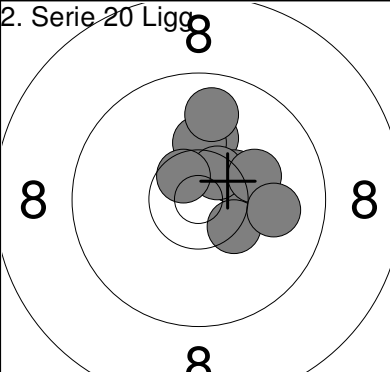
Prøve Ligg 	1: 9.3 ← 2: 9.3 ← 3: 9.4 ↗ 4: 10.8x ↘ 5: 10.7x ← <hr/> Serie 47.0 Total 190.0	2. Serie 20 Ligg 	1: 10.1 ↑ 2: 10.2 ↑ 3: 10.2 → 4: 10.4x ↗ 5: 10.4x ↘ 6: 10.5x ↗ 7: 10.2 → 8: 10.6x ↗ 9: 10.0 → 10: 9.8 ↑ <hr/> Serie 99.0 Total 289.0
--	---	--	---

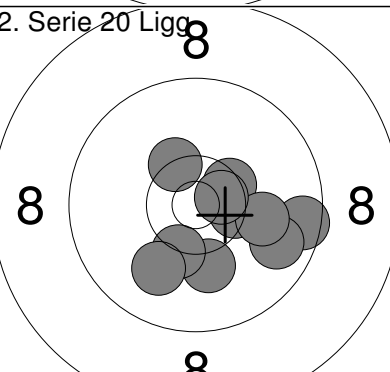
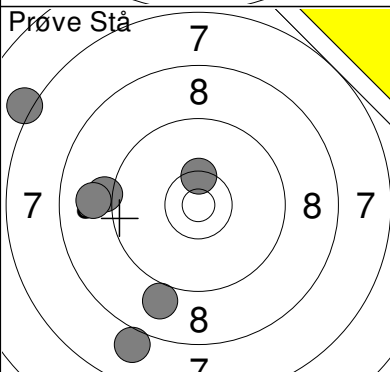
2. Serie 20 Ligg 	11: 10.4x → 12: 10.1 ↘ 13: 10.4x ↗ 14: 9.5 → 15: 9.8 ↘ 16: 10.4x ↗ 17: 10.3x ↘ 18: 10.1 → 19: 10.0 ↘ 20: 10.6x → <hr/> Serie 98.0 Total 387.0	Prøve Stå 	1: 9.0 ↘ 2: 8.0 ↘ 3: 9.2 ← 4: 9.0 ← 5: 7.2 ↗ 6: 10.4x ↑ <hr/> Serie 52.0 Total 387.0
---	--	--	---

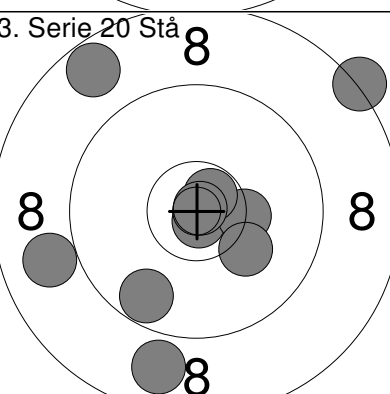
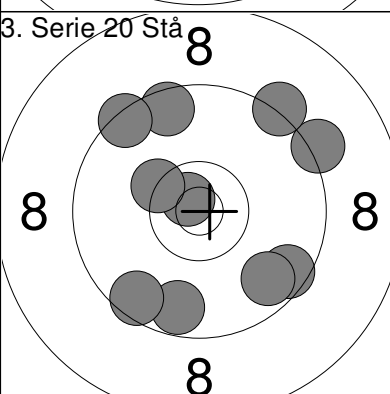
3. Serie 20 Stå 	1: 10.8x ↘ 2: 10.3x → 3: 10.7x ↗ 4: 10.9x ↗ 5: 8.3 → 6: 8.9 ↘ 7: 9.7 ↘ 8: 8.9 ← 9: 8.7 ↗ 10: 10.2 ↘ <hr/> Serie 91.0 Total 478.0	3. Serie 20 Stå 	11: 9.2 → 12: 9.6 ↑ 13: 9.3 ↗ 14: 10.7x ↗ 15: 9.6 ↘ 16: 9.7 ↘ 17: 9.6 ↘ 18: 9.7 ↘ 19: 9.4 ↗ 20: 10.3x ↗ <hr/> Serie 92.0 Total 570.0
--	---	--	---

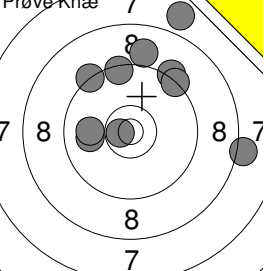
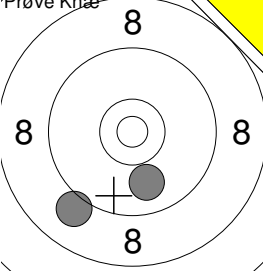
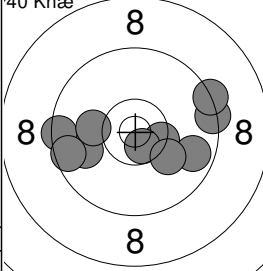
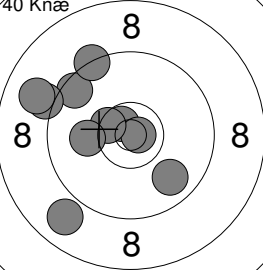
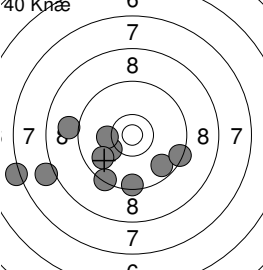
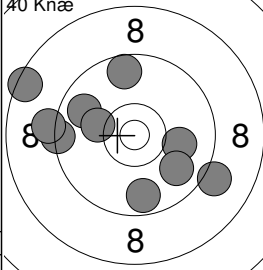
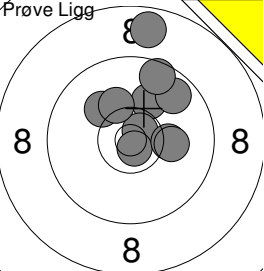
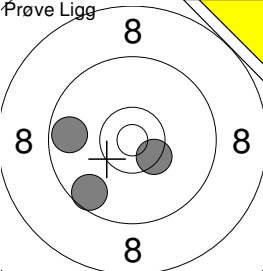
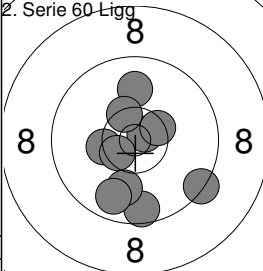
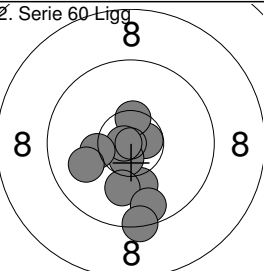
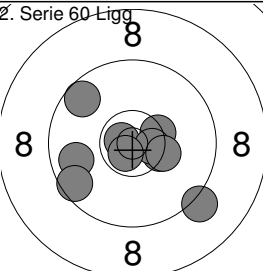
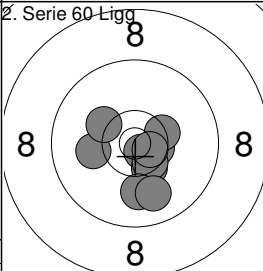
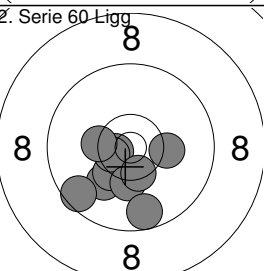
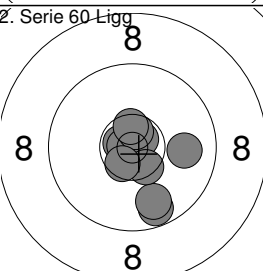
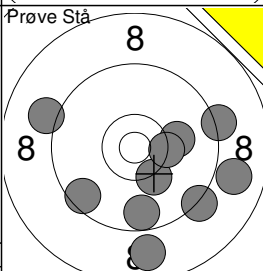
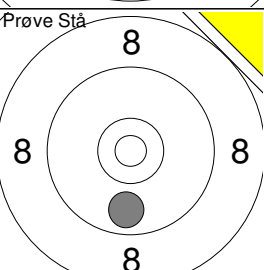
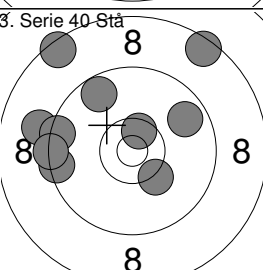
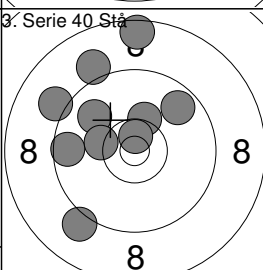
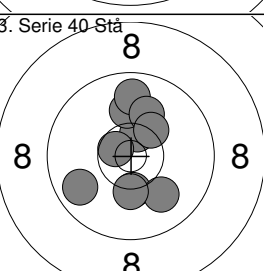
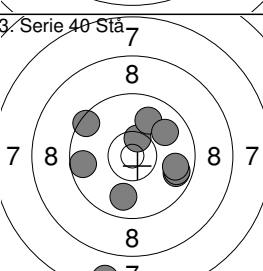
Prøve Knæ 	1: 7.9 ↗ 2: 10.7x ← 3: 9.2 ↗ 4: 9.3 ↗ 5: 9.0 ↗ 6: 9.9 ← 7: 9.3 ↗ 8: 9.4 ↗ 9: 9.9 ← 10: 8.2 ↗ <hr/> Serie 88.0 Total 0.0	Prøve Knæ 	11: 9.0 ↘ 12: 9.9 ↘ <hr/> Serie 18.0 Total 0.0	40 Knæ 	1: 10.4x ↗ 2: 9.4 ↗ 3: 9.9 ↗ 4: 9.5 ↗ 5: 10.6x ↘ 6: 9.6 ↗ 7: 9.7 ↗ 8: 9.3 ↗ 9: 10.1 ↗ 10: 10.1 ↗ <hr/> Serie 94.0 Total 94.0
40 Knæ 	11: 10.7x ↗ 12: 9.5 ↗ 13: 9.1 ↗ 14: 10.8x ↗ 15: 10.5x ↗ 16: 9.8 ↗ 17: 9.0 ↗ 18: 10.1 ↗ 19: 9.3 ↗ 20: 8.9 ↗ <hr/> Serie 93.0 Total 187.0	40 Knæ 	21: 10.2 ↗ 22: 10.2 ← 23: 9.6 ↗ 24: 7.2 ↗ 25: 9.4 ↗ 26: 9.4 ↗ 27: 9.8 ↗ 28: 8.1 ↗ 29: 9.4 ↗ 30: 9.0 ↗ <hr/> Serie 89.0 Total 276.0	40 Knæ 	31: 9.7 ↘ 32: 10.0 ↗ 33: 9.8 ↗ 34: 9.9 ↗ 35: 9.4 ↗ 36: 10.2 ↗ 37: 9.6 ↗ 38: 8.5 ↗ 39: 9.1 ↗ 40: 9.2 ↗ <hr/> Serie 91.0 Total 367.0
Prøve Ligg 	1: 10.1 ↗ 2: 10.1 ↗ 3: 9.7 ↗ 4: 8.7 ↗ 5: 9.6 ↗ 6: 10.7x ↗ 7: 10.8x ↗ 8: 10.2 ↗ 9: 10.1 ↗ 10: 10.2 ↗ <hr/> Serie 96.0 Total 367.0	Prøve Ligg 	11: 9.6 ↗ 12: 9.7 ← 13: 10.4x ↗ <hr/> Serie 28.0 Total 367.0	2. Serie 60 Ligg 	1: 10.7x ↗ 2: 10.3x ← 3: 9.6 ↘ 4: 10.5x ↘ 5: 10.0 ↘ 6: 9.9 ↘ 7: 10.4x ↘ 8: 10.4x ↘ 9: 9.4 ↘ 10: 9.8 ↘ <hr/> Serie 96.0 Total 463.0
2. Serie 60 Ligg 	11: 10.7x ↗ 12: 10.1 ↗ 13: 10.5x ↗ 14: 10.6x ↗ 15: 10.1 ↗ 16: 10.8x ↗ 17: 9.7 ↗ 18: 9.4 ↗ 19: 10.3 ↗ 20: 10.0 ↗ <hr/> Serie 98.0 Total 561.0	2. Serie 60 Ligg 	21: 10.4x ↗ 22: 10.4x ↗ 23: 9.2 ↗ 24: 9.8 ↗ 25: 10.7x ↗ 26: 10.6x ↗ 27: 9.6 ↗ 28: 10.3x ↗ 29: 10.7x ↗ 30: 9.6 ↗ <hr/> Serie 96.0 Total 657.0	2. Serie 60 Ligg 	31: 10.5x ↗ 32: 10.4x ↗ 33: 10.7x ↗ 34: 10.1 ↗ 35: 10.4x ↗ 36: 10.5x ↗ 37: 10.0 ↗ 38: 10.6x ↗ 39: 9.9 ↗ 40: 10.2 ↗ <hr/> Serie 99.0 Total 756.0
2. Serie 60 Ligg 	41: 10.6x ↗ 42: 10.1 ↗ 43: 10.2 ↗ 44: 10.3x ↗ 45: 10.5x ↗ 46: 10.2 ↗ 47: 9.7 ↗ 48: 10.4x ↗ 49: 9.6 ↗ 50: 10.3x ↗ <hr/> Serie 98.0 Total 854.0	2. Serie 60 Ligg 	51: 10.7x ↗ 52: 9.7 ↗ 53: 9.8 ↗ 54: 10.8x ↗ 55: 10.7x ↗ 56: 10.5x ↗ 57: 10.6x ↗ 58: 10.6x ↗ 59: 9.9 ↗ 60: 10.5x ↗ <hr/> Serie 97.0 Total 951.0	Prøve Stå 	1: 8.9 ↗ 2: 8.9 ↗ 3: 10.3 ↗ 4: 10.1 ↗ 5: 9.7 ↗ 6: 9.1 ↗ 7: 10.3x ↗ 8: 9.2 ↗ 9: 9.5 ↗ 10: 9.3 ↗ <hr/> Serie 91.0 Total 951.0
Prøve Stå 	11: 9.8 ↘ <hr/> Serie 9.0 Total 951.0	3. Serie 40 Stå 	1: 9.1 ↗ 2: 8.5 ↗ 3: 9.4 ↗ 4: 10.3 ↗ 5: 9.4 ↗ 6: 10.5x ↗ 7: 9.7 ↗ 8: 9.3 ↗ 9: 8.5 ↗ 10: 9.7 ↗ <hr/> Serie 90.0 Total 1041.0	3. Serie 40 Stå 	11: 9.1 ↗ 12: 9.1 ↗ 13: 10.3 ↗ 14: 8.6 ↗ 15: 10.7x ↗ 16: 9.9 ↗ 17: 10.2 ↗ 18: 9.1 ↗ 19: 9.6 ↗ 20: 9.7 ↗ <hr/> Serie 92.0 Total 1133.0
3. Serie 40 Stå 	21: 10.3 ↗ 22: 10.0 ↘ 23: 10.5x ↗ 24: 10.2 ↗ 25: 10.6x ↗ 26: 10.1 ↗ 27: 9.8 ↗ 28: 9.8 ↗ 29: 10.1 ↗ 30: 10.3x ↗ <hr/> Serie 98.0 Total 1231.0	3. Serie 40 Stå 	31: 9.7 ↗ 32: 10.5x ↗ 33: 9.9 ↗ 34: 9.9 ↗ 35: 7.7 ↘ 36: 9.8 ↗ 37: 9.5 ↗ 38: 9.7 ↗ 39: 9.8 ↗ 40: 9.6 ↗ <hr/> Serie 89.0 Total 1320.0		

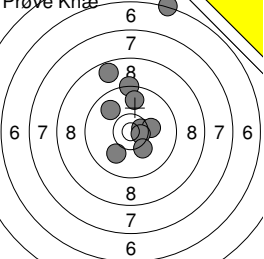
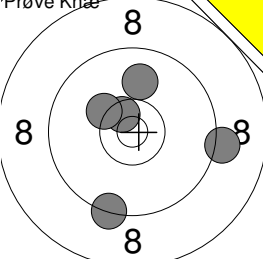
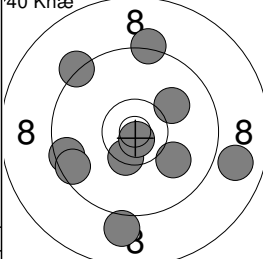
	<p>1: 6.3 ↑</p> <p>2: 8.7 ↑</p> <p>3: 9.3 ↑</p> <p>4: 9.8 ↑</p> <p>5: 10.0 ↓</p> <p>6: 10.6x →</p> <p>7: 10.2 →</p> <p>8: 9.9 →</p> <p>9: 10.6x ↓</p> <p>10: 10.2 ↓</p>		<p>11: 10.6x ↑</p> <p>12: 10.0 ↑</p> <p>13: 9.2 →</p> <p>14: 10.3 →</p> <p>15: 9.3 ↓</p>		<p>1: 9.3 ↑</p> <p>2: 9.3 ↑</p> <p>3: 9.0 ↓</p> <p>4: 9.5 ↓</p> <p>5: 10.4x ↓</p> <p>6: 9.6 ↓</p> <p>7: 10.8x ↓</p> <p>8: 10.0 ↓</p> <p>9: 10.1 ↓</p> <p>10: 8.9 ↓</p>
	Serie 91.0		Serie 48.0		Serie 93.0
	Total 0.0		Total 0.0		Total 93.0

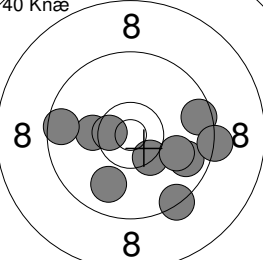
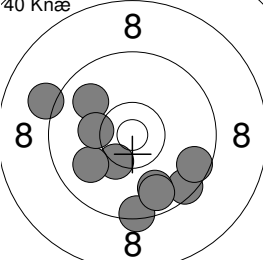
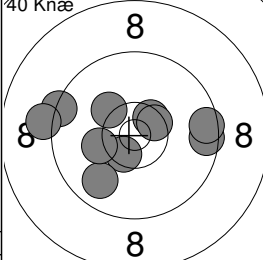
	<p>11: 9.6 ↓</p> <p>12: 10.4x ↓</p> <p>13: 10.2 ↓</p> <p>14: 9.8 ↓</p> <p>15: 9.3 ↓</p> <p>16: 10.5x →</p> <p>17: 9.9 ↓</p> <p>18: 9.6 ↓</p> <p>19: 10.0 ↓</p> <p>20: 9.3 ↓</p>		<p>21: 9.9 ↓</p> <p>22: 9.5 ↓</p> <p>23: 10.3x ↓</p> <p>24: 10.0 ↓</p> <p>25: 10.2 ↓</p> <p>26: 9.4 ↓</p> <p>27: 9.8 ↓</p> <p>28: 9.7 ↓</p> <p>29: 9.6 ↓</p> <p>30: 9.1 ↓</p>		<p>31: 9.4 ↓</p> <p>32: 10.5x ↑</p> <p>33: 9.5 ↓</p> <p>34: 10.2 ↓</p> <p>35: 9.5 ↓</p> <p>36: 10.5x ↓</p> <p>37: 10.5x ↓</p> <p>38: 9.8 ↓</p> <p>39: 9.1 ↓</p> <p>40: 10.2 ↓</p>
	Serie 94.0		Serie 93.0		Serie 95.0
	Total 187.0		Total 280.0		Total 375.0

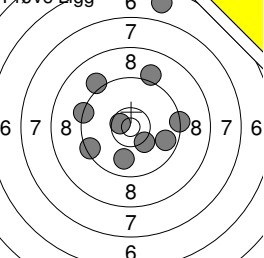
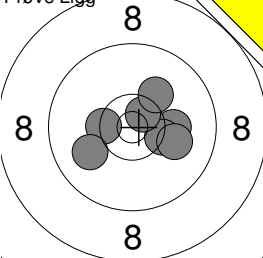
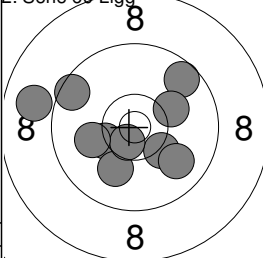
	<p>1: 6.7 ↑</p> <p>2: 9.1 ↑</p> <p>3: 9.7 ↑</p> <p>4: 9.3 ↑</p> <p>5: 9.1 ↑</p> <p>6: 9.4 ↓</p> <p>7: 10.6x ↑</p> <p>8: 10.3 ↓</p> <p>9: 9.9 ↓</p> <p>10: 9.3 ↓</p>		<p>11: 10.1 ↓</p> <p>12: 10.3x ↓</p> <p>13: 10.6x ↓</p> <p>14: 10.4x ↓</p> <p>15: 10.2 ↓</p> <p>16: 10.1 ↓</p> <p>17: 10.0 ↓</p>		<p>1: 9.6 ↑</p> <p>2: 10.3x ↓</p> <p>3: 10.0 ↓</p> <p>4: 10.3 ↓</p> <p>5: 8.9 ↓</p> <p>6: 9.9 ↓</p> <p>7: 10.6x ↓</p> <p>8: 9.5 ↓</p> <p>9: 10.2 ↓</p> <p>10: 10.1 ↓</p>
	Serie 89.0		Serie 70.0		Serie 95.0
	Total 375.0		Total 375.0		Total 470.0

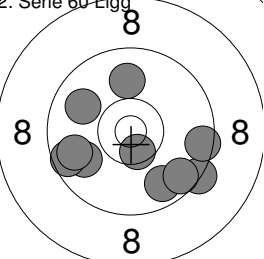
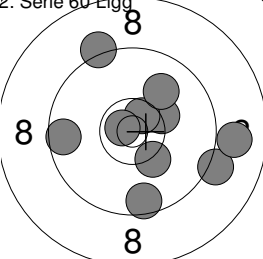
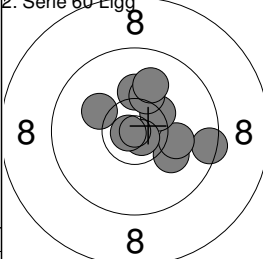
	<p>11: 10.5x ↓</p> <p>12: 9.9 ↓</p> <p>13: 9.9 ↓</p> <p>14: 9.6 ↓</p> <p>15: 9.8 ↓</p> <p>16: 10.0 ↓</p> <p>17: 9.7 ↓</p> <p>18: 9.4 ↓</p> <p>19: 9.5 ↓</p> <p>20: 9.6 ↓</p>		<p>21: 9.2 ↓</p> <p>22: 9.6 ↓</p> <p>23: 8.9 ↓</p> <p>24: 10.3 ↓</p> <p>25: 10.3x ↓</p> <p>26: 10.6x ↓</p> <p>27: 10.0 ↓</p> <p>28: 10.7x ↓</p> <p>29: 9.6 ↓</p> <p>30: 9.2 ↓</p>		<p>31: 9.5 ↓</p> <p>32: 10.2 ↓</p> <p>33: 10.1 ↓</p> <p>34: 10.1 ↓</p> <p>35: 10.4x ↓</p> <p>36: 10.8x ↓</p> <p>37: 10.1 ↓</p> <p>38: 10.8x ↓</p> <p>39: 10.2 ↓</p> <p>40: 10.0 ↓</p>
	Serie 92.0		Serie 94.0		Serie 99.0
	Total 562.0		Total 656.0		Total 755.0

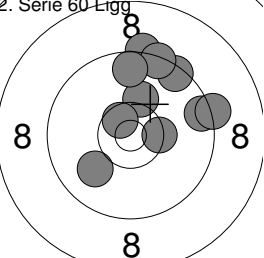
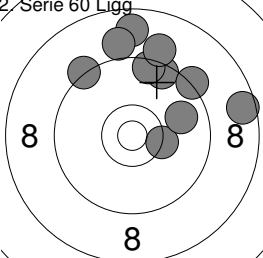
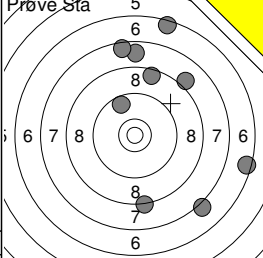
	<p>41: 10.4x ↓</p> <p>42: 10.2 ↓</p> <p>43: 10.0 ↓</p> <p>44: 9.5 ↓</p> <p>45: 9.3 ↓</p> <p>46: 9.4 ↓</p> <p>47: 9.3 ↓</p> <p>48: 10.6x ↓</p> <p>49: 9.4 ↓</p> <p>50: 9.6 ↓</p>		<p>51: 9.5 ↓</p> <p>52: 10.3x ↓</p> <p>53: 8.6 ↓</p> <p>54: 9.5 ↓</p> <p>55: 9.3 ↓</p> <p>56: 9.3 ↓</p> <p>57: 8.7 ↓</p> <p>58: 9.1 ↓</p> <p>59: 9.0 ↓</p> <p>60: 9.8 ↓</p>		<p>1: 8.6 ↑</p> <p>2: 7.8 ↑</p> <p>3: 5.3 ↑</p> <p>4: 7.5 ↑</p> <p>5: 6.5 ↑</p> <p>6: 8.1 ↑</p> <p>7: 6.5 ↓</p> <p>8: 9.6 ↓</p> <p>9: 8.3 ↓</p> <p>10: 7.1 ↓</p>
	Serie 94.0		Serie 89.0		Serie 71.0
	Total 849.0		Total 938.0		Total 938.0

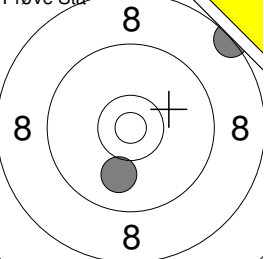
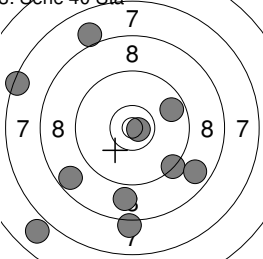
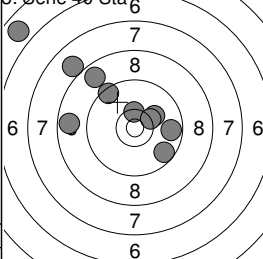
	<p>11: 8.3 ↓</p> <p>12: 10.0 ↓</p>		<p>1: 9.3 ↓</p> <p>2: 8.9 ↓</p> <p>3: 6.9 ↓</p> <p>4: 8.1 ↓</p> <p>5: 8.7 ↓</p> <p>6: 9.7 ↓</p> <p>7: 10.8x ↓</p> <p>8: 7.4 ↓</p> <p>9: 8.7 ↓</p> <p>10: 8.0 ↓</p>		<p>11: 9.7 ↓</p> <p>12: 5.8 ↓</p> <p>13: 10.2 ↓</p> <p>14: 10.4x ↓</p> <p>15: 9.7 ↓</p> <p>16: 8.0 ↓</p> <p>17: 8.8 ↓</p> <p>18: 10.3x ↓</p> <p>19: 8.7 ↓</p> <p>20: 9.5 ↓</p>
	Serie 18.0		Serie 81.0		Serie 86.0
	Total 938.0		Total 1019.0		Total 1105.0

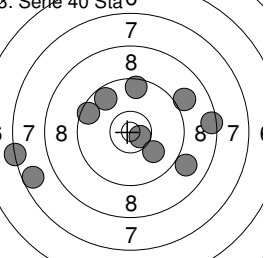
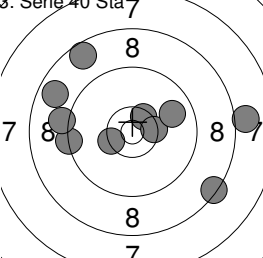
	<p>21: 10.6x ↓</p> <p>22: 9.6 ↓</p> <p>23: 9.0 ↓</p> <p>24: 9.7 ↓</p> <p>25: 9.0 ↓</p> <p>26: 7.3 ↓</p> <p>27: 9.5 ↓</p> <p>28: 8.4 ↓</p> <p>29: 10.0 ↓</p> <p>30: 7.6 ↓</p>		<p>31: 10.5x ↓</p> <p>32: 8.0 ↓</p> <p>33: 10.4x ↓</p> <p>34: 10.4x ↓</p> <p>35: 8.6 ↓</p> <p>36: 8.8 ↓</p> <p>37: 9.3 ↓</p> <p>38: 9.8 ↓</p> <p>39: 9.1 ↓</p> <p>40: 8.4 ↓</p>		
	Serie 87.0		Serie 89.0		
	Total 1192.0		Total 1281.0		

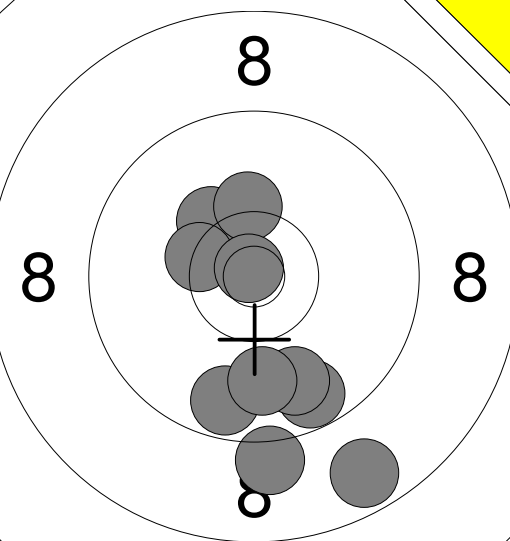
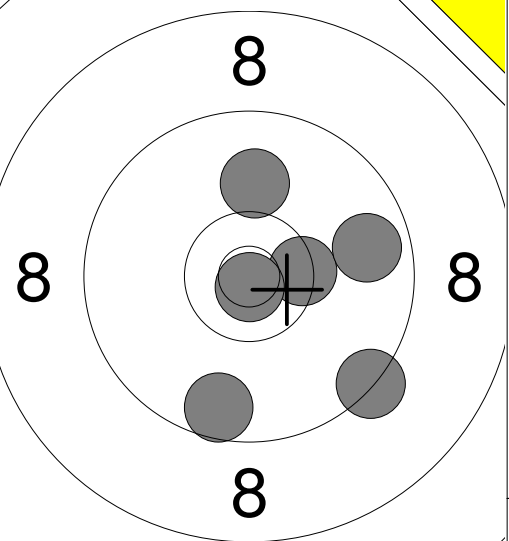
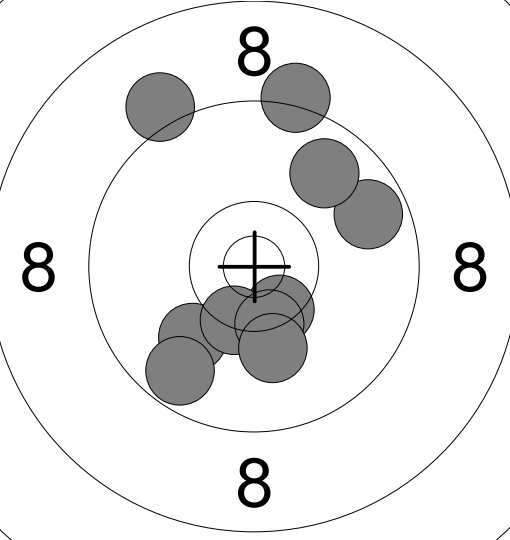
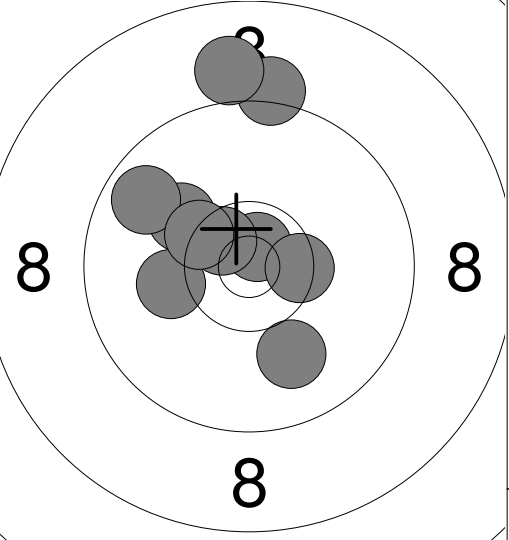
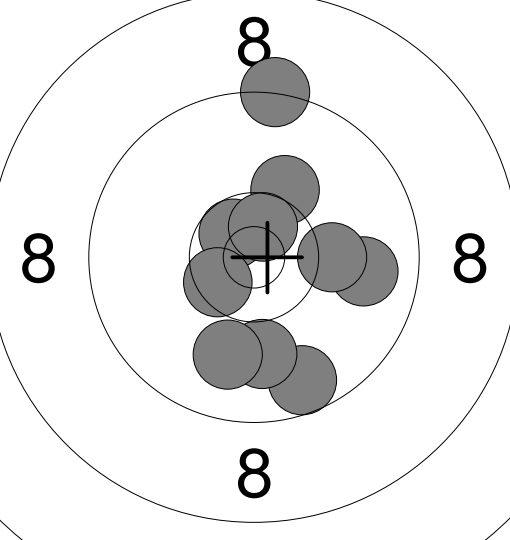
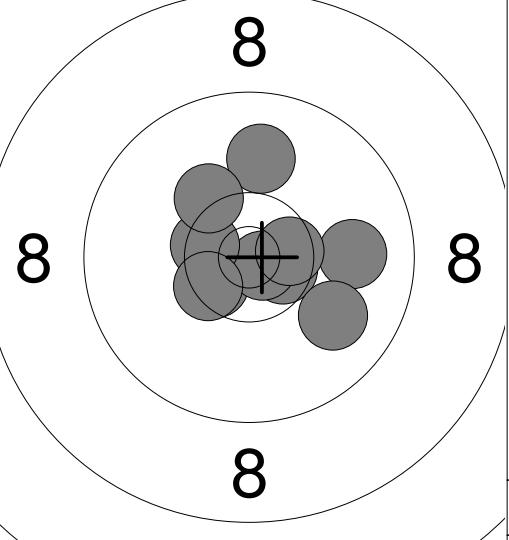
Prøve		Prøve	
7	8	7	8
	1: 9.7 ↓ 2: 10.2 ↗ 3: 9.1 ↓ 4: 10.2 ↑ 5: 10.4x ↙ 6: 9.7 ↓ 7: 8.7 ↓ 8: 9.8 ↓ 9: 9.9 ↓ 10: 10.9x ↗		11: 10.4x → 12: 9.7 → 13: 9.3 ↘ 14: 10.0 ↑ 15: 10.8x ↓ 16: 9.6 ↓
7	8	7	8
Serie 98.6		Serie 59.8	
Total 0.0		Total 0.0	
7	8	7	8
40 Skud		40 Skud	
7	8	7	8
Serie 98.9		Serie 100.3	
Total 98.9		Total 199.2	
7	8	7	8
40 Skud		40 Skud	
7	8	7	8
Serie 100.7		Serie 103.4	
Total 299.9		Total 403.3	

<p>Prøve</p>	<p>1: 9.7 ↓ 2: 10.3 ↗ 3: 10.6x ↓ 4: 10.4x ← 5: 10.0 ↓ 6: 9.7 ← 7: 10.5x → 8: 8.3 ↑ 9: 10.3 → 10: 9.8 ↖</p>	<p>Prøve</p>	<p>11: 9.4 ↑ 12: 9.2 ↗ 13: 10.6x ↖ 14: 8.6 ↗ 15: 10.3x ← 16: 9.8 ← 17: 9.2 ↓ 18: 10.1 ↖ 19: 8.9 → 20: 9.1 →</p>
Serie	99.6	Serie	95.2
Total	0.0	Total	0.0

<p>Prøve</p>	<p>21: 9.4 ↗ 22: 10.3x ↑</p>	<p>40 Skud</p>	<p>1: 10.1 → 2: 9.8 ↖ 3: 10.0 ↗ 4: 10.2 ↑ 5: 10.8x ↓ 6: 9.6 → 7: 9.2 ↓ 8: 10.2 ↓ 9: 10.0 ↓ 10: 10.4x ↖</p>
Serie	19.7	Serie	100.3
Total	0.0	Total	100.3

<p>40 Skud</p>	<p>11: 8.8 ↓ 12: 10.6x ↓ 13: 9.5 ↓ 14: 9.2 ↓ 15: 9.6 ↗ 16: 9.0 ↓ 17: 8.4 ↗ 18: 10.4x ↓ 19: 9.4 ↗ 20: 9.4 ↓</p>	<p>40 Skud</p>	<p>21: 9.8 ↖ 22: 9.9 ↓ 23: 10.3 ↓ 24: 10.0 ↓ 25: 10.5x ← 26: 9.3 ↑ 27: 10.4x ↗ 28: 10.1 ↖ 29: 9.3 ↓ 30: 10.4x ↓</p>
Serie	94.3	Serie	100.0
Total	194.6	Total	294.6

<p>40 Skud</p>	<p>31: 9.3 ↑ 32: 10.4x ↖ 33: 10.3x ↓ 34: 8.9 → 35: 10.1 ↗ 36: 10.1 ↓ 37: 9.5 ↖ 38: 9.7 ↑ 39: 10.4x ↓ 40: 9.4 ↖</p>		
Serie	98.1		
Total	392.7		

Prøve 	Prøve
60 Skud 	60 Skud
60 Skud 	60 Skud
60 Skud 	60 Skud
Serie 94.7 Total 0.0	Serie 49.2 Total 0.0
Serie 99.1 Total 99.1	Serie 101.6 Total 200.7
Serie 97.4 Total 298.1	Serie 98.2 Total 396.3
Serie 98.7 Total 495.0	Serie 103.0 Total 598.0

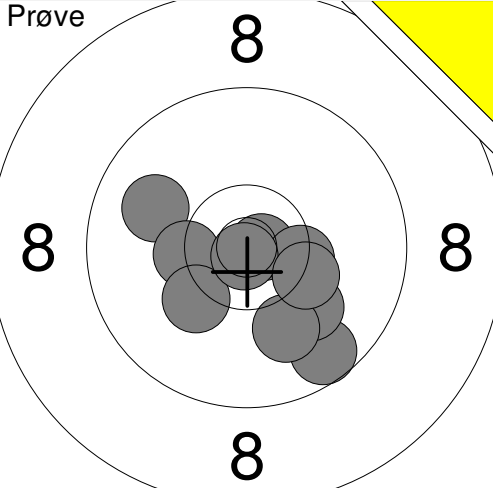
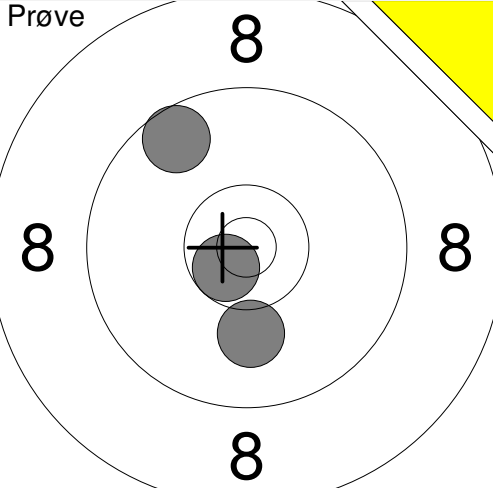
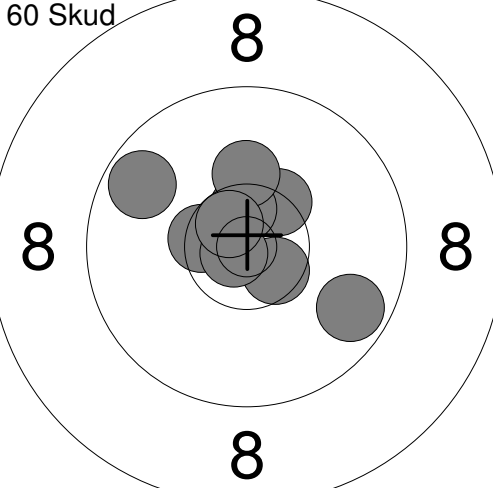
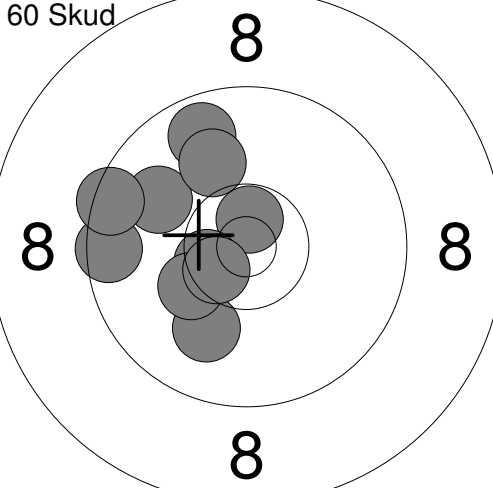
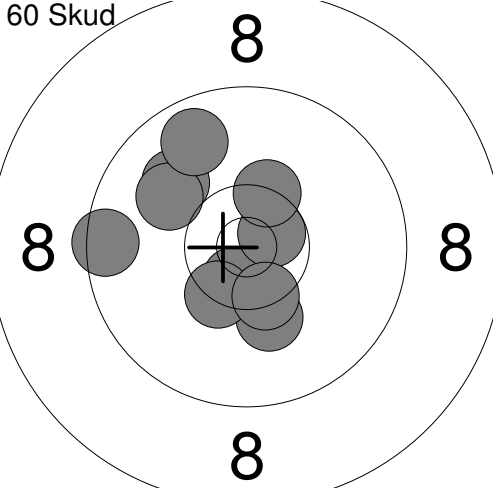
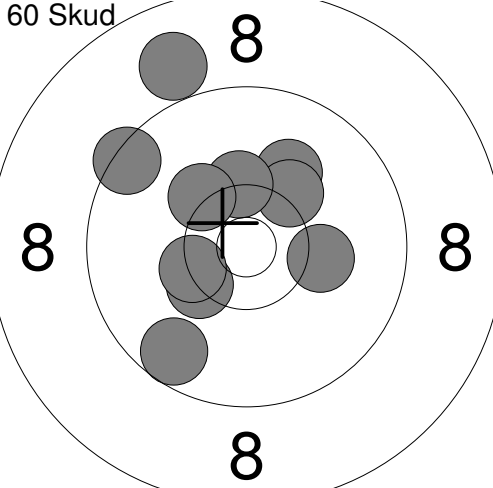
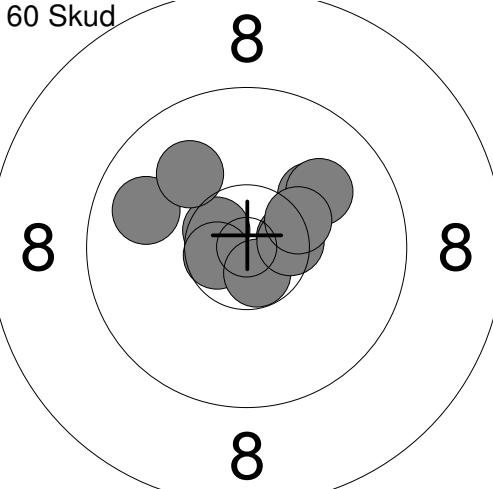
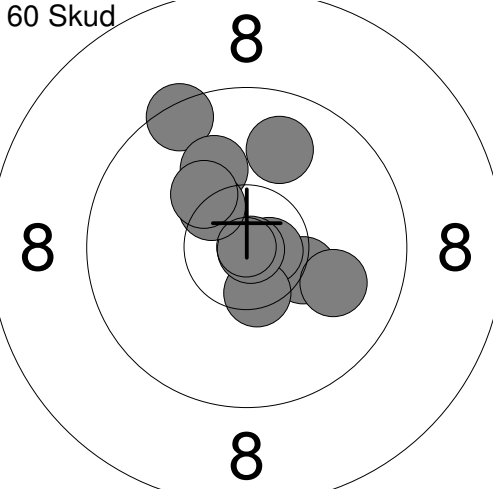
Hold	Skive	Kim Jensen	
119	10		
50m	Kolding		
01.08.2015	DSU stævne 2015	Aalborg Skyttekreds	
Prøve		1: 9.6 ↘ 2: 10.1 ↘ 3: 10.0 ↘ 4: 10.8x → 5: 9.9 ↗ 6: 10.3x ← 7: 10.2 ↘ 8: 10.4x → 9: 10.9x ↓ 10: 10.3 ↘ Serie 102.5 Total 0.0	Prøve  11: 10.7x ↙ 12: 9.6 ↗ 13: 10.1 ↓ Serie 30.4 Total 0.0
60 Skud		1: 10.4x ↗ 2: 9.7 ↖ 3: 10.7x ↗ 4: 10.6x ↘ 5: 10.6x ↑ 6: 9.7 ↘ 7: 10.2 ↑ 8: 10.5x ← 9: 10.8x ↙ 10: 10.7x ↗ Serie 103.9 Total 103.9	60 Skud  11: 10.7x ↑ 12: 9.7 ↗ 13: 10.0 ↓ 14: 9.5 ← 15: 9.9 ↖ 16: 10.5x ← 17: 9.5 ← 18: 10.0 ↗ 19: 10.3 ↙ 20: 10.6x ↙ Serie 100.7 Total 204.6
60 Skud		21: 10.6x ↓ 22: 10.0 ↗ 23: 10.0 ↗ 24: 10.2 ↓ 25: 10.4x ↘ 26: 9.5 ← 27: 10.7x ↗ 28: 9.7 ↗ 29: 10.4x ↓ 30: 10.4x ↑ Serie 101.9 Total 306.5	60 Skud  31: 10.3x ↙ 32: 10.4x ← 33: 10.1 ↗ 34: 10.2 ↗ 35: 9.6 ↘ 36: 9.4 ↖ 37: 10.2 → 38: 10.3x ↑ 39: 8.9 ↗ 40: 10.3 ↗ Serie 99.7 Total 406.2
60 Skud		41: 10.1 ↗ 42: 10.0 ↗ 43: 10.6x ↖ 44: 10.6x ← 45: 10.5x → 46: 10.7x ↓ 47: 9.8 ← 48: 10.0 ↗ 49: 10.5x → 50: 10.3x ↗ Serie 103.1 Total 509.3	60 Skud  51: 9.4 ↗ 52: 10.3x → 53: 10.7x → 54: 10.0 → 55: 10.5x ↓ 56: 10.1 ↗ 57: 9.9 ↗ 58: 10.9x → 59: 10.4x ↗ 60: 10.3 ↗ Serie 102.5 Total 611.8

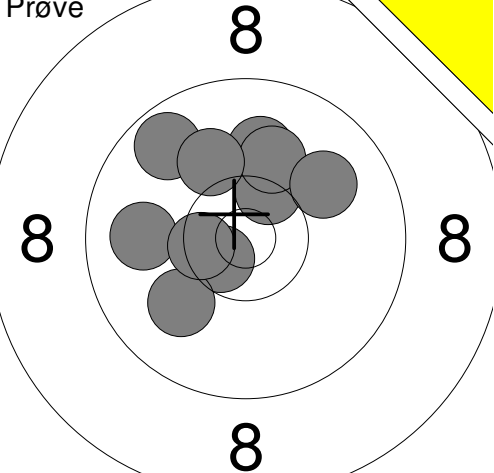
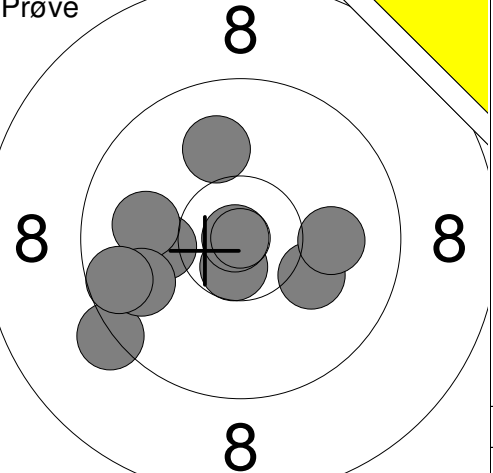
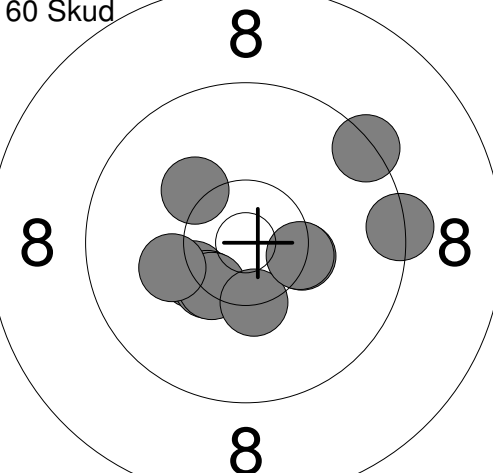
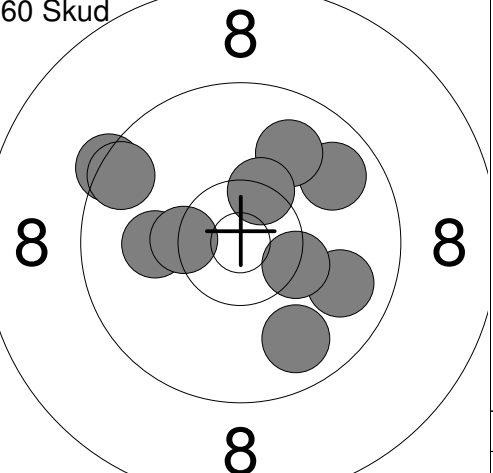
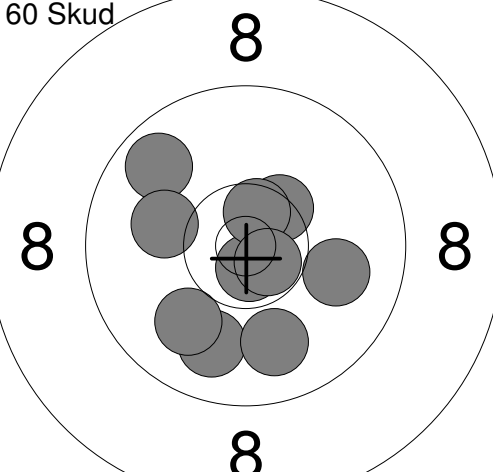
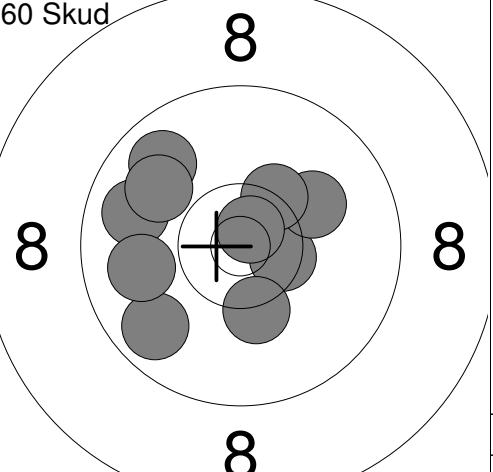
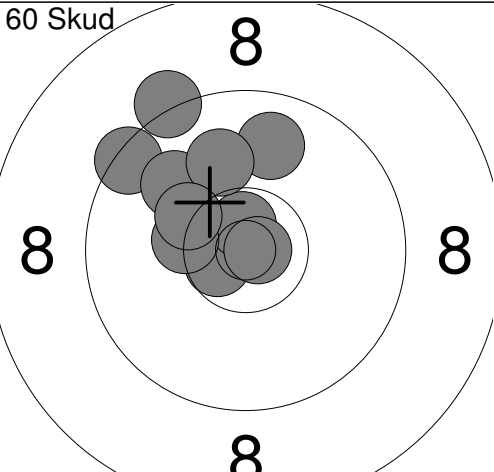
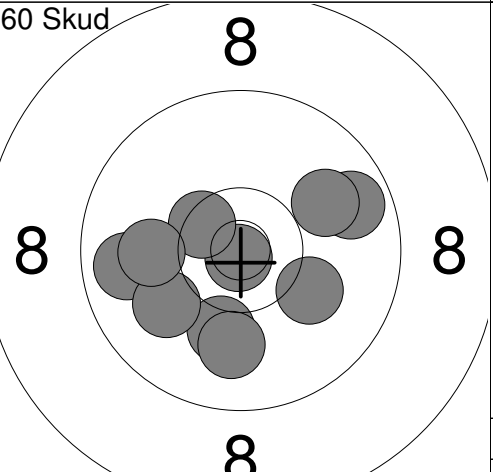
<p>Prøve</p> 	<p>1: 10.6x ↙ 2: 10.0 ↑ 3: 10.4x ↗ 4: 9.7 ↖ 5: 9.9 ← 6: 10.1 ↑ 7: 10.0 ↙ 8: 10.5x ← 9: 10.1 ↑ 10: 10.0 ↗</p> <p>Serie 101.3 Total 0.0</p>	<p>Prøve</p> 	<p>11: 10.1 → 12: 9.3 ↙ 13: 10.1 ← 14: 10.0 ← 15: 9.8 ← 16: 9.6 ← 17: 10.0 ↑ 18: 10.6x ↓ 19: 10.0 → 20: 10.9x ←</p> <p>Serie 100.4 Total 0.0</p>
<p>60 Skud</p> 	<p>1: 10.3x ↙ 2: 10.4x ↙ 3: 10.4x ↙ 4: 9.4 ↗ 5: 10.4x → 6: 10.3x ↓ 7: 10.4x → 8: 10.2 ↗ 9: 9.3 → 10: 10.2 ←</p> <p>Serie 101.3 Total 101.3</p>	<p>60 Skud</p> 	<p>11: 9.8 ↓ 12: 9.8 ↗ 13: 10.1 ← 14: 9.4 ↖ 15: 10.4x ← 16: 9.8 → 17: 10.3x → 18: 9.9 ↗ 19: 9.5 ↖ 20: 10.4x ↗</p> <p>Serie 99.4 Total 200.7</p>
<p>60 Skud</p> 	<p>21: 9.7 ↖ 22: 9.9 ↓ 23: 10.0 → 24: 10.4x ↗ 25: 10.0 ↙ 26: 10.7x ↓ 27: 10.6x ↗ 28: 9.9 ↓ 29: 10.1 ← 30: 10.7x ↘</p> <p>Serie 102.0 Total 302.7</p>	<p>60 Skud</p> 	<p>31: 9.8 ↖ 32: 9.8 ← 33: 10.5x → 34: 9.7 ↙ 35: 10.1 ↗ 36: 10.3x ↗ 37: 10.7x ↗ 38: 9.9 ← 39: 10.3 ↓ 40: 9.9 ↖</p> <p>Serie 101.0 Total 403.7</p>
<p>60 Skud</p> 	<p>41: 10.6x ← 42: 10.7x ↑ 43: 9.4 ↖ 44: 9.8 ↑ 45: 10.0 ↗ 46: 10.0 ↑ 47: 9.2 ↗ 48: 10.8x → 49: 10.3x ← 50: 10.3 ↗</p> <p>Serie 101.1 Total 504.8</p>	<p>60 Skud</p> 	<p>51: 9.8 ← 52: 9.7 → 53: 10.1 ↓ 54: 10.9x ↓ 55: 10.5x ↖ 56: 10.0 ↓ 57: 10.1 → 58: 10.0 ↗ 59: 10.0 ↙ 60: 10.0 ←</p> <p>Serie 101.1 Total 605.9</p>